

EMERGENCY RESCUE TRAINING

SM 14-1 (Pocket Edition)
(formerly PM-2)



DEPARTMENT OF DEFENSE
OFFICE OF CIVIL DEFENSE

EMERGENCY RESCUE TRAINING



SM 14-1 (Pocket Edition)
(formerly PM-2)

(Reprinted January 1963)

DEPARTMENT OF DEFENSE
OFFICE OF CIVIL DEFENSE

UNITED STATES
GOVERNMENT PRINTING OFFICE
WASHINGTON : 1961

CONTENTS

	Page
Purpose of Student Manual	1
Missions and Duties of Rescue Squads	2
Organization of Rescue Squads	2
Local Rescue Program Application	3
Chain of Command	5
Leadership	5
Reports	6
Operational Procedure	7
Utility Damage	9
Building Damage	11
Casualty Handling	13
Stretcher Handling	16
Ropes and Knots	18
Lifting Devices	20
Ladders	22
Block and Tackle	24
Rigging	26
Shoring	32
Wall Breaching	36
Basement Rescue	37
High Rescue	38
Trenching, Tunneling, and Shafting	41
Masks	45
Equipment	46

PURPOSE OF STUDENT MANUAL

This student manual on rescue contains a résumé of most of the subjects covered in the Office of Civil Defense instructor guides on basic, light, and heavy duty rescue. It is a guide to emergency "spot" training of expanded rescue forces by civil defense rescue cadremen who have been trained in OCD-approved light or heavy duty rescue. It is not intended to replace the complete lesson plans in the instructor guides. Rescue cadremen should determine the training time for each subject on the basis of:

- A. Background experience of personnel to be trained.
- B. Ratio of untrained to trained personnel.
- C. Equipment available.
- D. Time available for training.

MISSION AND DUTIES OF RESCUE SQUADS

The mission of rescue squads in a natural disaster or an enemy attack is to—

- A. Locate and extricate persons entrapped in damaged buildings, shelters, vehicles, and other enclosures, or from radiologically contaminated areas, giving first aid during rescue and removing or arranging removal of persons to safety, and
- B. Recover critical supplies, materials, and equipment, needed for survival.

There are two major types of rescue squads—light duty and heavy duty.

- A. Light duty rescue squads will release injured or uninjured people trapped in lightly damaged structures or shelters with limited access problems.
- B. Heavy duty rescue squads will release injured and uninjured people trapped in heavily damaged enclosures or shelters with complicated access problems.

ORGANIZATION OF RESCUE SQUADS

- A. *Light Duty Rescue Squad*—26 men: squad leader, deputy squad leader, and 6 teams of 4 men each, 1 of whom is designated team leader.

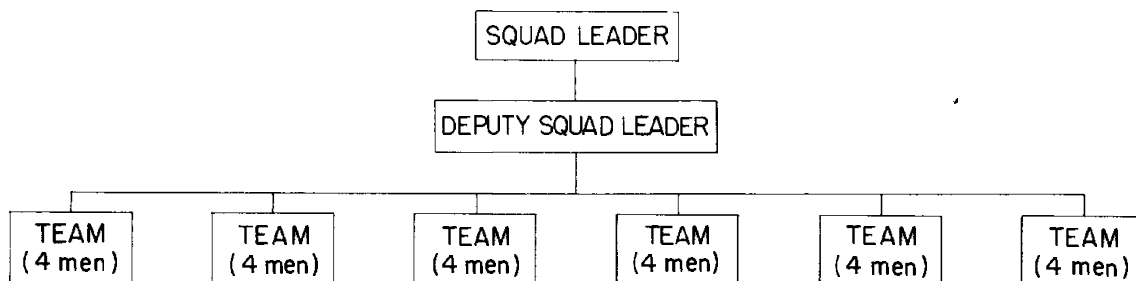

FIGURE 1.—*Organization of light duty rescue squad.*

B. *Heavy Duty Rescue Squad*—26 men: squad leader, deputy squad leader, and 3 teams of 8 men each, 1 of whom is designated team leader.

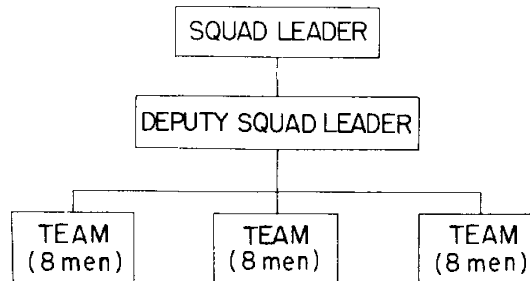

FIGURE 2.—*Organization of heavy duty rescue squad.*

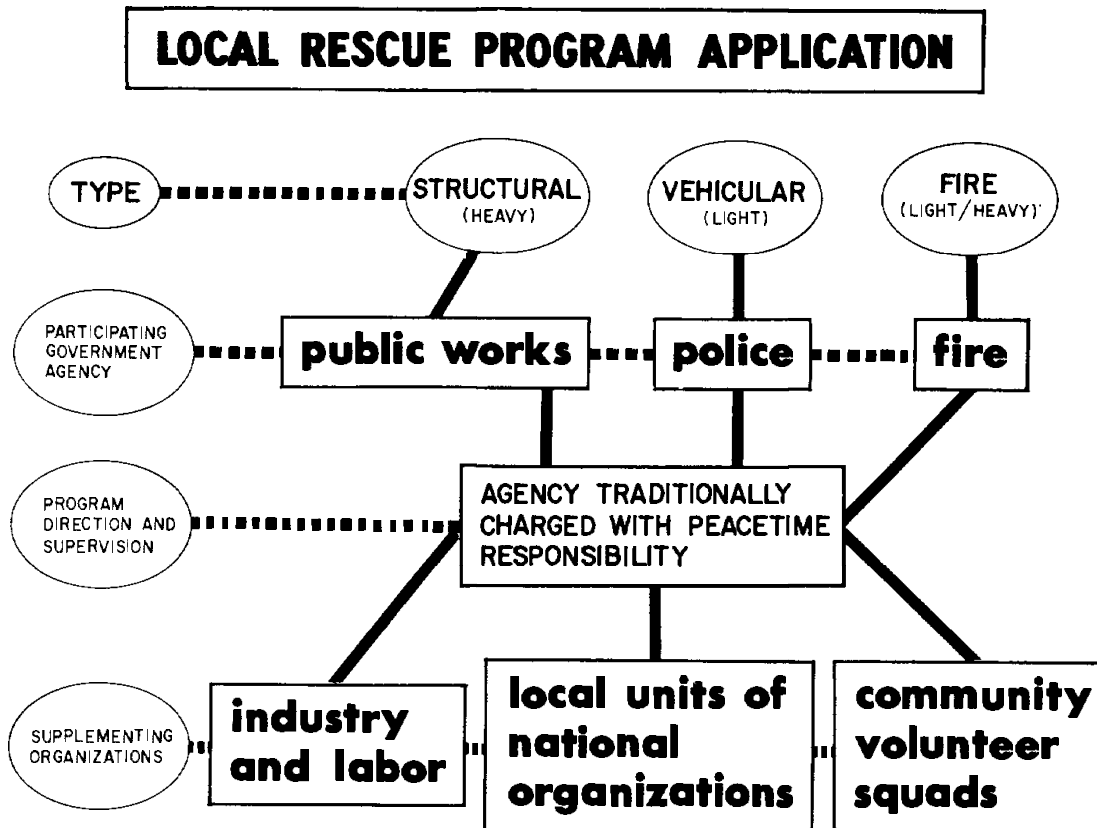

FIGURE 3.—*Local rescue program application.*

A. Staff

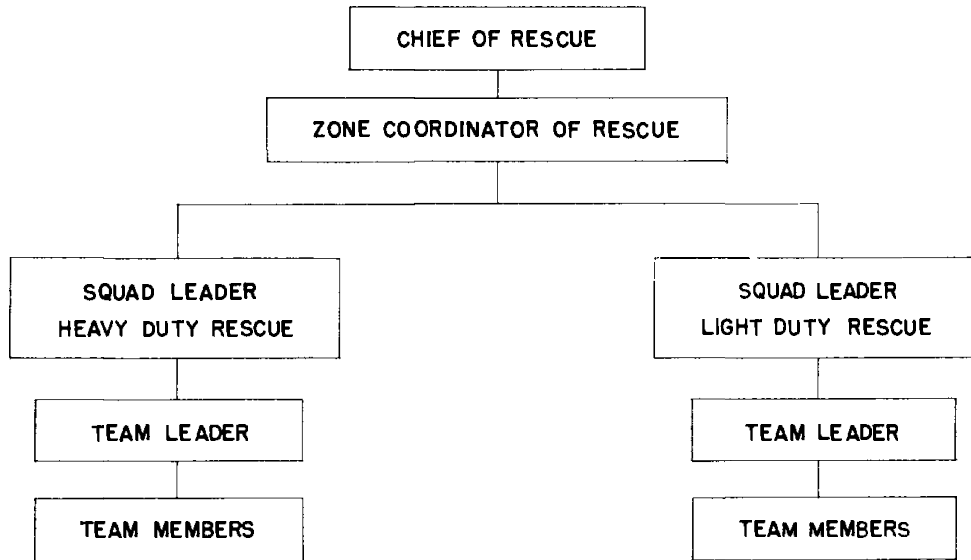

FIGURE 4.—Chain of command—staff.

B. Operations

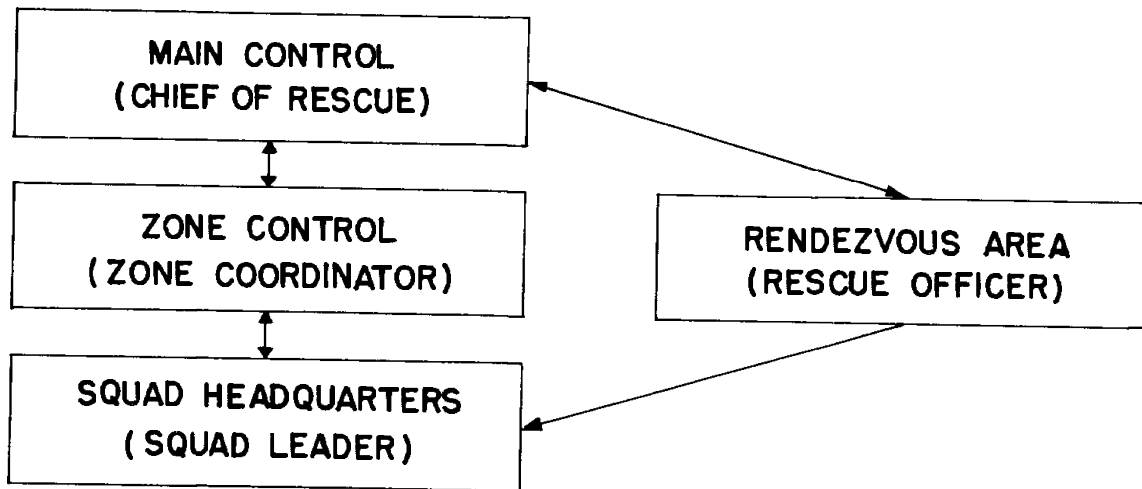

FIGURE 5.—Chain of command—operations.

CHAIN OF COMMAND

A chief of rescue will be designated by the head of the State or local governmental department to which the service is assigned, and will be under his general direction.

Chain-of-command will be the same for rescue as for other divisions of the major governmental department to which it is assigned.

Within the chain-of-command, an officer will be designated to command each rendezvous area (prearranged assembly points for manpower and equipment).

Regardless of which governmental department has the major rescue responsibility, other departments will be responsible for a limited amount of rescue and for cooperation with the rescue service.

LEADERSHIP

Experienced leadership is one of the most important factors in rescue. Rescue leaders must be highly trained in the full range of rescue skills and techniques. In an emergency, they must know the use of inventories, the location of all personnel and equipment within their jurisdiction, the characteristics of the local geography, and the methods of cooperating with other governmental departments and agencies that will be involved in rescue and salvage. They must command respect, be able to inspire confidence, and get the best from their men. They must be able to weigh the entire situation and make quick decisions.

REPORTS

A. *From Team Leader to Squad Leader*

1. Information to be supplied:
 - a. Location of rescue site.
 - b. Date, time, and team identification.
 - c. Total number of rescues:
 - (1) Names and addresses of persons rescued.
 - (2) Disposition of persons rescued.
 - d. Team status.
 - e. Signature of team leader.

B. *From Squad Leader to Rescue Officer of Rendezvous Area*

1. Information to be supplied:
 - a. Location of rescue site.
 - b. Date, time, and squad identification.
 - c. Total number of rescues.
 - (1) Names and addresses of persons rescued.
 - (2) Disposition of persons rescued.
 - d. Injuries and fatalities to rescuers.
 - e. Injuries and fatalities to persons assisting rescuers (including names, disposition, and remarks).
 - f. Squad status.
 - g. Signature of squad leader.

OPERATIONAL PROCEDURE

An officer from a participating governmental agency, responsible for rescue, will be assigned to each rescue rendezvous area. He will be responsible to the chief of rescue for expansion of the rescue forces in his area, using evacuees and support area personnel with special skills to augment his cadre of trained rescue workers. Trained rescue workers, under the direction of the officer responsible for rescue in the rendezvous area, will use this student manual as a guide to rapid training in an emergency.

Rescue squad leaders will receive their orders from the rescue officer in the rendezvous area, who will dispatch the squads according to priorities set up by the chief of rescue.

A. *Reporting to Scene of Operations*

1. Immediately on reporting to the scene of rescue operations the squad leader should make his reconnaissance. At the same time his squad should check equipment and prepare for operations.
2. On completion of his reconnaissance the squad leader should inform his deputy squad leader and team leaders of the situation and assign job priorities.

B. *Stages of Rescue*

Stage I, Immediate Rescue—releasing persons who can be seen or heard and those in shelters and other areas whose exact location is known.

Stage II, Exploration—searching places where casualties may still be alive.

Stage III, Selected Debris Removal—careful removal of debris to release persons still known to be missing.
Stage IV, General Rubble Clearance—stripping area systematically as a last resort when persons are still unaccounted for.

C. *Marking of Searched Buildings*

The “D” warns of danger. The “R” indicates that the rescue service has completed the search.

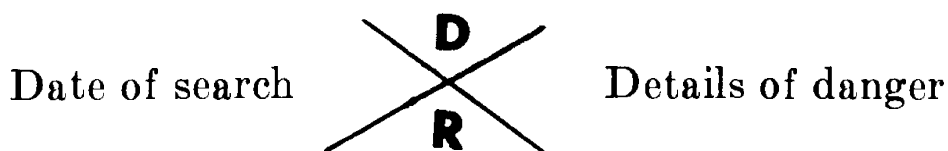

UTILITY DAMAGE

A. *Types*

1. Refrigerants.

a. Hazards.

- (1) Explosion.
- (2) Breathing—toxic, suffocant.
- (3) Freezing.
- (4) Irritation—may produce blindness.

b. Precautions.

- (1) Avoid igniting pockets of refrigerants.
- (2) Avoid touching ruptured refrigeration systems with bare hands.

2. Heating systems.

a. Hazards.

- (1) Burns.
- (2) Scalding
- (3) Asphyxiation.
- (4) Explosion and fire.

b. Precautions.

- (1) Cut off flow of fuel if liquid or gas.
- (2) Do not use steel or iron tools.

3. Gas.

a. Hazards.

- (1) Asphyxiation.
- (2) Paralysis.
- (3) Explosion.

b. Precautions.

- (1) Ventilate area if possible.
- (2) Do not smoke.
- (3) Do not use naked lights.
- (4) Let burning gas mains burn.
- (5) Use gas masks if available.

4. Water/sewer.
 - a. Hazards.
 - (1) Flooding.
 - b. Precautions.
 - (1) Valving off water main.
5. Electricity.
 - a. Hazards.
 - (1) Wires and cables hanging from poles.
 - b. Precautions.
 - (1) In breaking contact of victim with live wire, use a nonconductor of electricity.
 - (2) Avoid high voltage wires.
 - (3) Use back of hand as a feeler if moving in the dark.

BUILDING DAMAGE

A. *Types of Construction*

1. Unframed (load bearing walls)—small apartment and individual home.
 - a. Walls support floors and roof.
 - b. Generally masonry or veneer.
2. Framed—large multistoried (hotels, hospitals, office buildings, schools, warehouses).
 - a. Steel or wood-reinforced concrete skeleton.
 - b. Frame supports floors and roof.

B. *Types of Collapses and Formation of Voids*

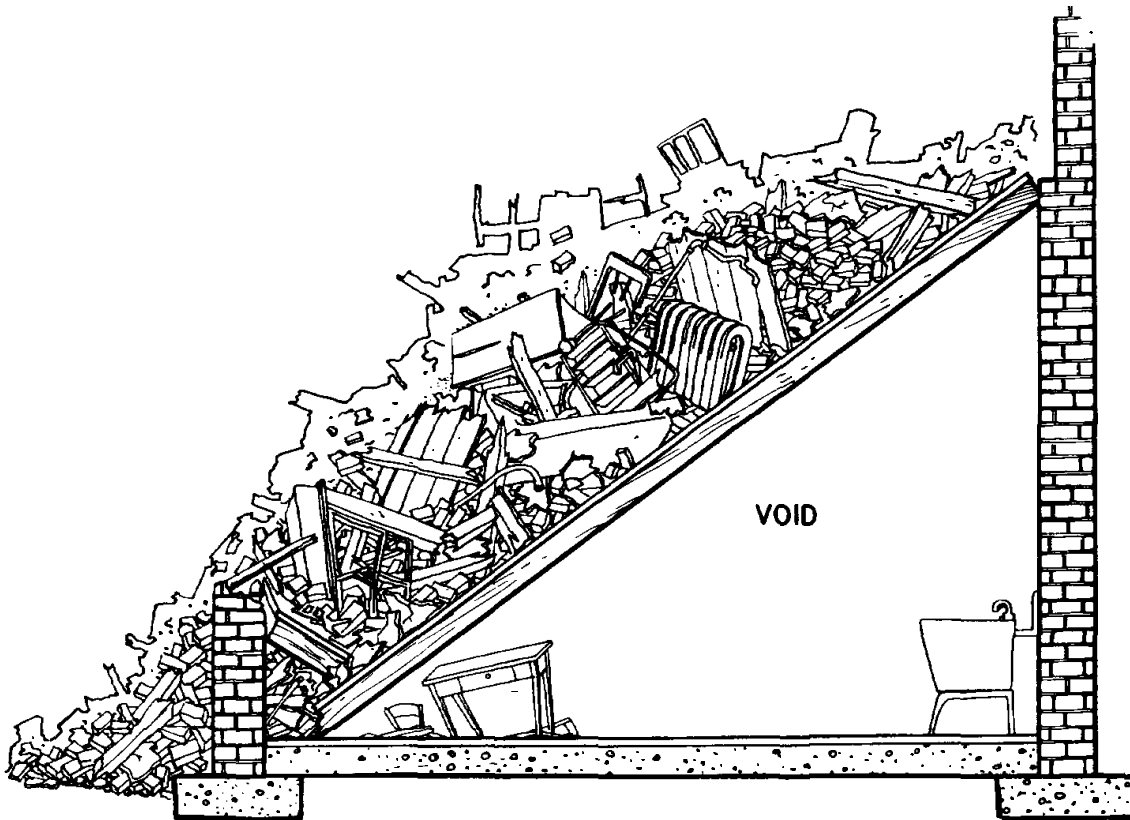

FIGURE 6.—*Lean-to floor collapse.*

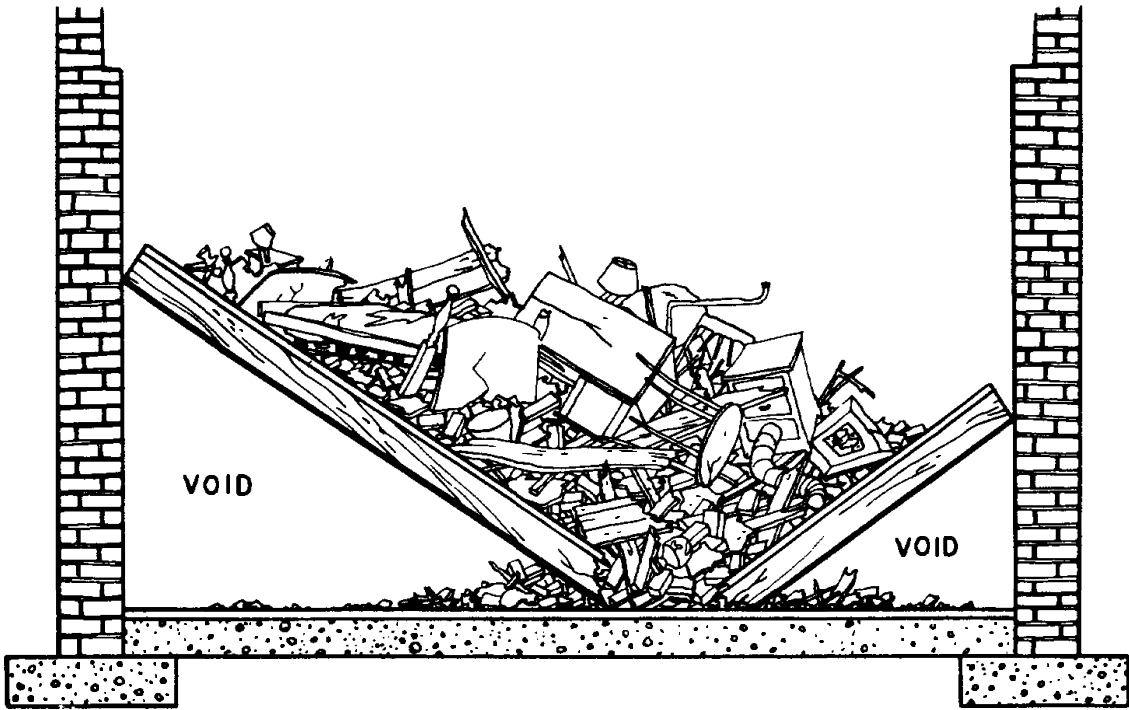

FIGURE 7.—*V-type floor collapse.*

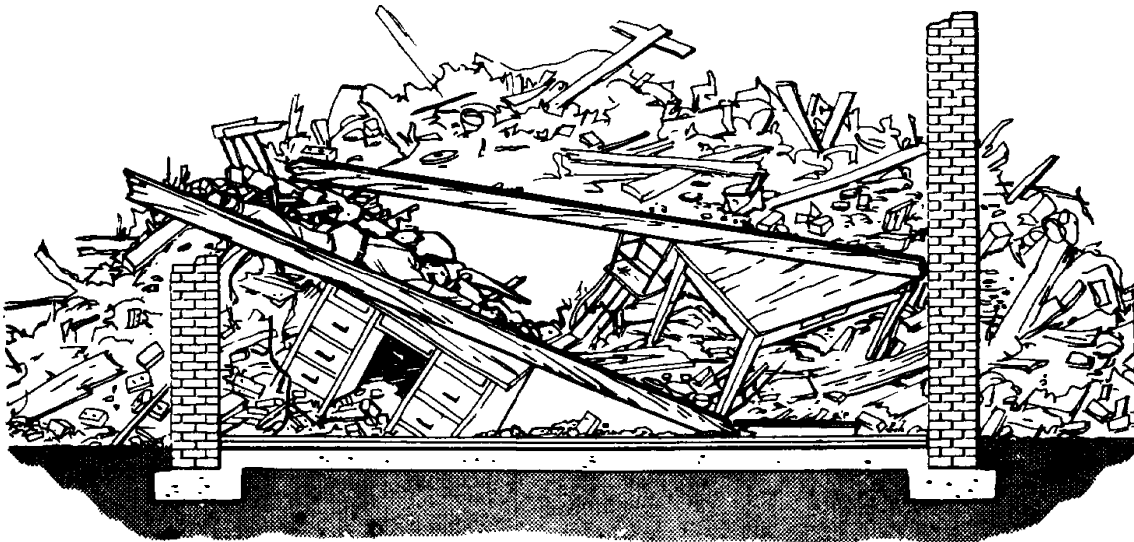

FIGURE 8.—*Pancake floor collapse.*

CASUALTY HANDLING

A. Rules for Handling Casualties

1. Determine nature of injury and give emergency first aid.
2. Make casualty as comfortable as possible.
3. Talk to casualty—reassure him that everything possible is being done for him.
4. Complete an emergency medical tag and secure it to the casualty.

EMERGENCY MEDICAL TAG		Serial No.
Name and Home Address of Casualty		
Sex:	Age:	
Location when Injured (Describe Exact Location)		
Found at (Describe Exact Location)		
Tagged: Date _____ Hour _____		
Type of Injury and Treatment (By First-Aid Worker)		
Name of F. A. Worker		
Diagnosis and Treatment at First-Aid Station		
Sedation	Dose:	Hour:
Morphine	Dose:	Hour:
Disposition	Date:	Hour:
Symbol of Station	Signature - N. D.	
(Binding Portion)		

SUPPLEMENTAL RECORD	
(Binding portion)	

FIGURE 9.—Emergency medical tag.

B. *Moving Casualties*
1. Carries, lifts, and drags.

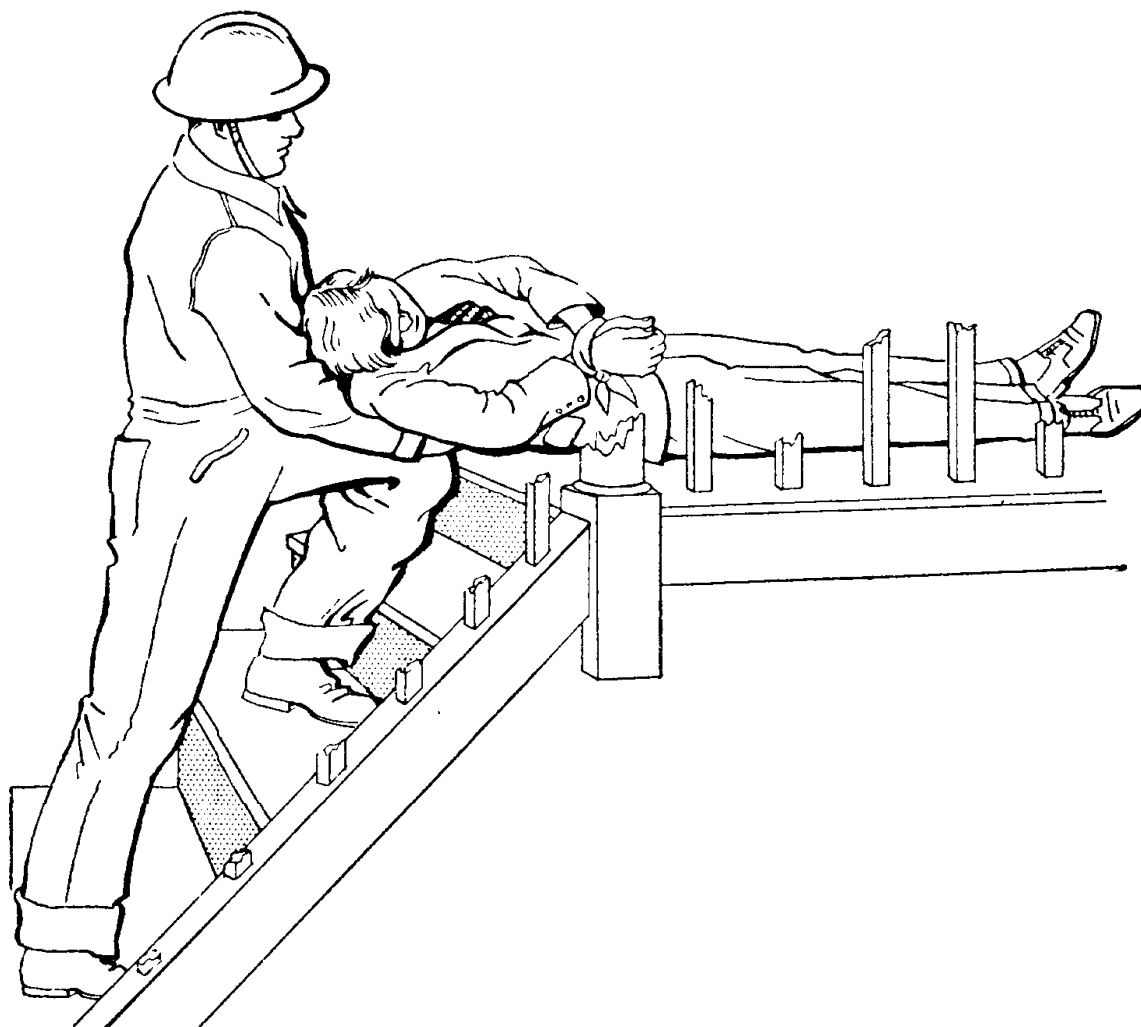

FIGURE 10.—*Incline drag.*



FIGURES 11 AND 12.—*Helping person down ladder A, B.*

STRETCHER HANDLING

A. Stretcher Blanketing

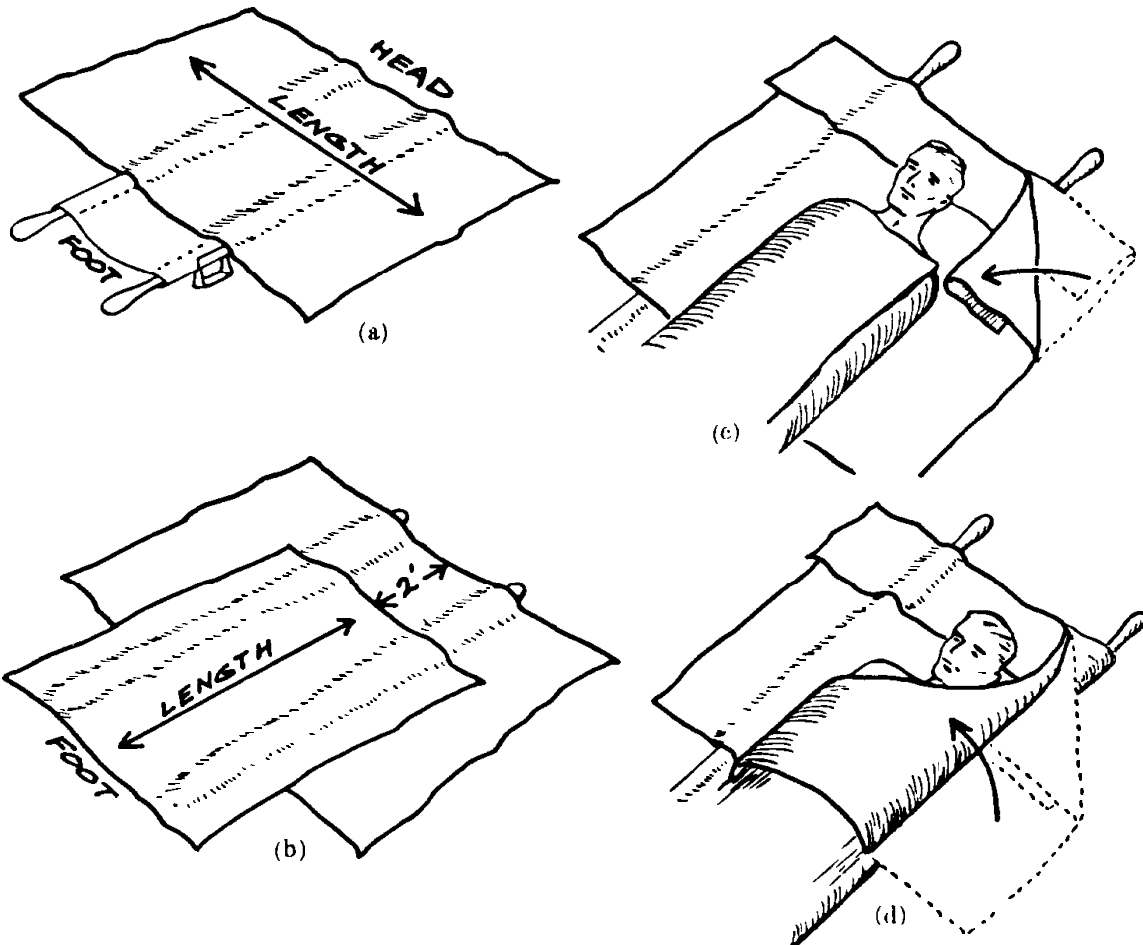

FIGURE 13.—*Four steps in stretcher blanketing.*

B. *Stretcher Lashing*

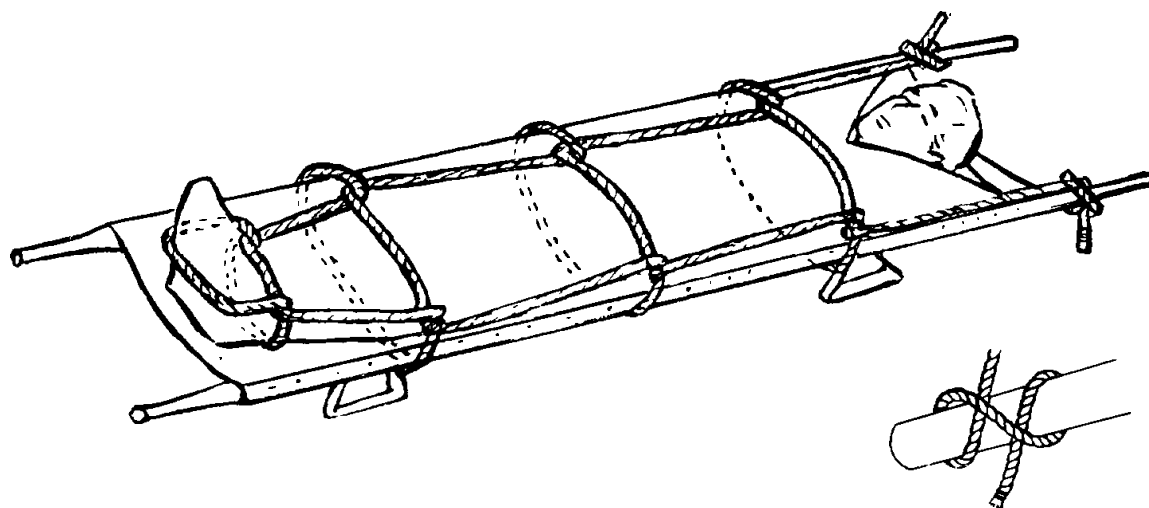

FIGURE 14.—*Stretcher lashing with clove hitch inset.*

C. *Transportation*

1. Methods of carry.

- a. Two-man stretcher carry.
- b. Four-man stretcher carry.

2. Precautions.

- a. Casualty should be carried feet first except up hill or stairs.
- b. Bearers should walk in cadence but not in step.
- c. When stretcher is to be carried over rubble it should be lashed.

ROPES AND KNOTS

A. *Half Hitch*

1. Used in stretcher lashing.

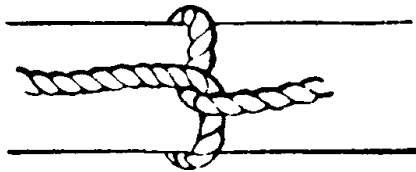

FIGURE 15.—*Half hitch.*

B. *Clove Hitch*

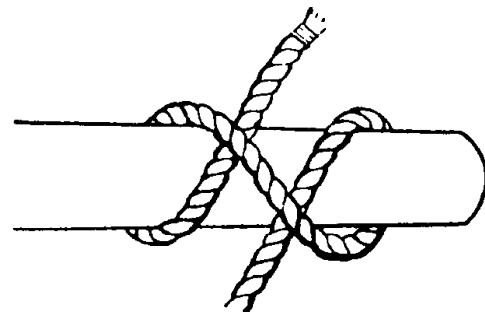

FIGURE 16.—*Clove hitch.*

C. *Sheet Bend or Becket*

1. Used to tie ropes together.

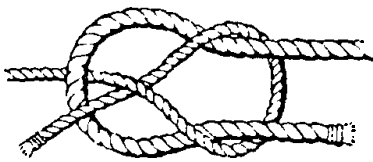

FIGURE 17.—*Sheet bend or becket.*

D. *Bowline*

1. A good secure knot.

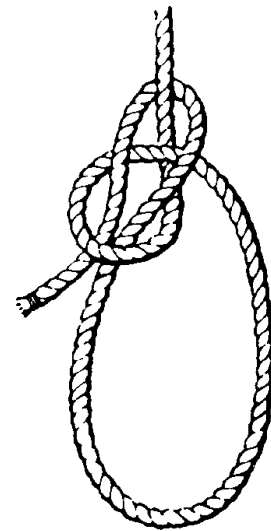

FIGURE 18.—*Bowline.*

E. *Bowline-on-a-Bight*

1. Provides two loops.

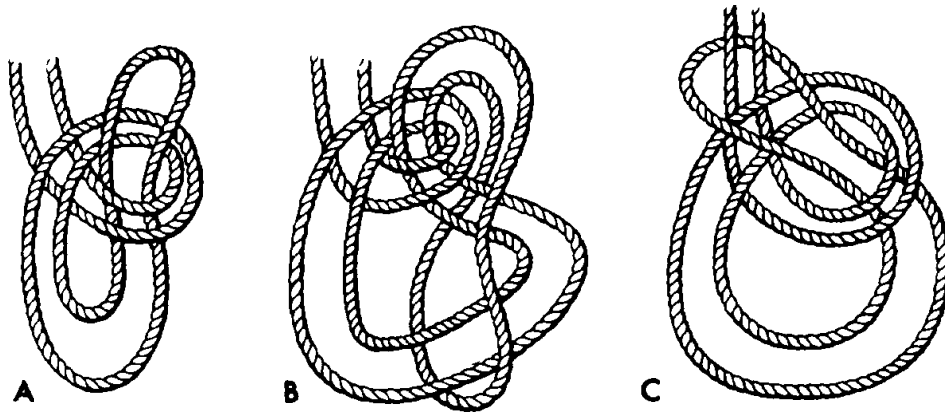

FIGURE 19.—*Bowline-on-a-bight.*

F. *Double Bowline*

1. Three-loop life basket.

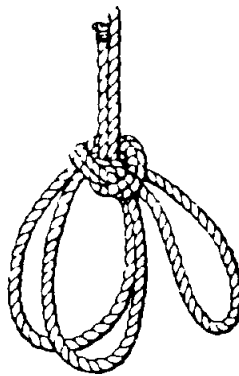

FIGURE 20.—*Double bowline.*

LIFTING DEVICES

A. *Manual Lifting*

1. Review of proper position.

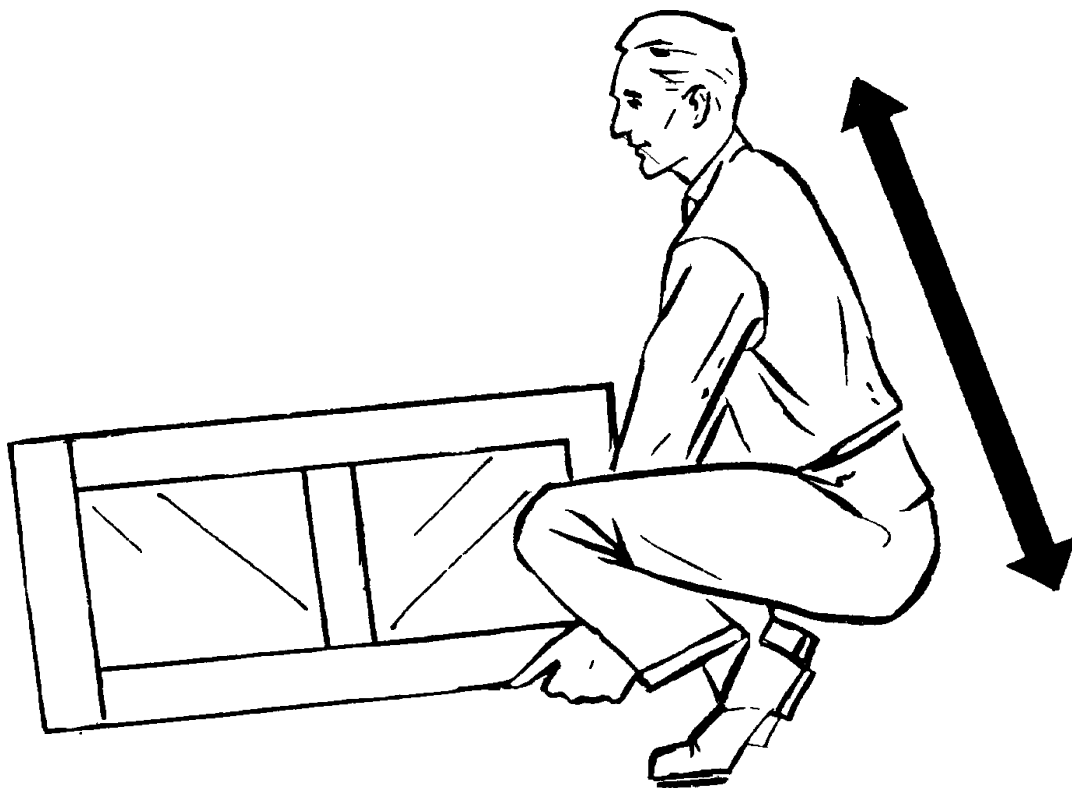

FIGURE 21.—*Manual lifting.*

B. *Mechanical Devices*

1. Lever.
2. Screw jack.
3. Ratchet jack.

C. *Precautions*

1. Work from a good foundation.
2. Pack as you jack.
3. Never leave jack under load.
4. Raise or lower jacks in unison slowly when using several jacks on one load.
5. Avoid letting jack contact any material except wood.
6. Avoid overloading or overextending jack.
7. Be sure jack handle fits socket.
8. Remove jack handle when not in use.

LADDERS

A. *Uses*

1. Entrance into upper story windows.
2. Rescue from upper story windows or basements.
3. As improvised stretcher.
4. Bridging gaps.

B. *Terminology*

1. *Wall ladder*—a ladder of only one section.
2. *Extension ladder*—a ladder of two sections: the bottom ladder, known as the *bed*; and the *fly* or extension part of the ladder with guide pawls and a lanyard to raise the ladder.
3. *Beam*—structural member in which rungs are supported.
4. *Rungs*—cross members between the beams used as steps.
5. *Heel or butt*—the bottom of a ladder.
6. *Top, tip, or head*—the top of a ladder.
7. *Dog*—a lock used to support the fly after it is raised.
8. *Tie rods*—metal rods which hold the entire ladder assembly together.

C. *Safe Ladder-Climbing Position*

D. *Ladder Leg Lock*

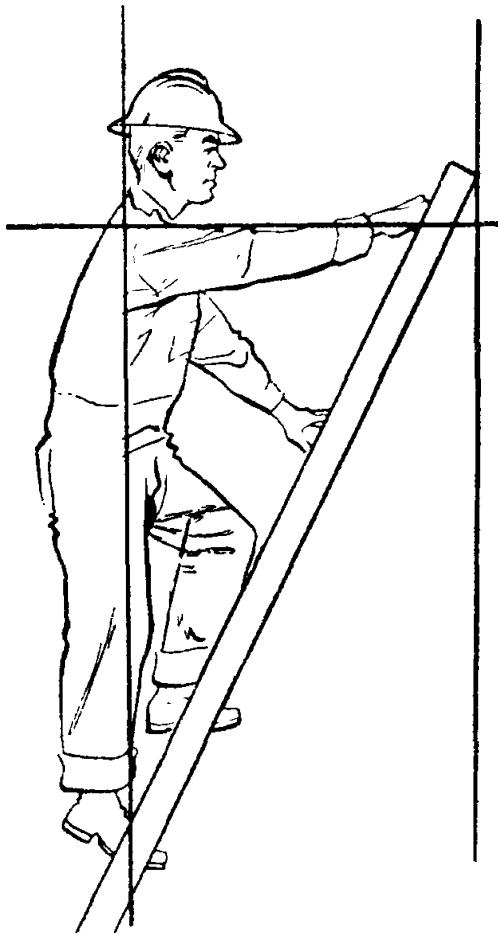

FIGURE 22.—*Safe ladder-climbing position.*



FIGURE 23.—*Ladder leg lock.*

BLOCK AND TACKLE

A. Terminology

1. *Block*—pulley in a shell.
2. *Tackle*—two or more properly reeved blocks.
3. *Sheave*—grooved pulley.
4. *Shell*—frame.
5. *Thimble*—part to which end of rope is attached.
6. *Standing block*—fixed block in tackle.
7. *Running block*—block attached to object to be moved.
8. *Overhauling blocks*—spreading blocks in tackle.
9. *Chock-a-block*—bringing blocks close together.
10. *Reeving the block*—passing the rope over the sheaves in proper order to prepare the blocks for use.
11. *Snatch block*—single block used to change direction.

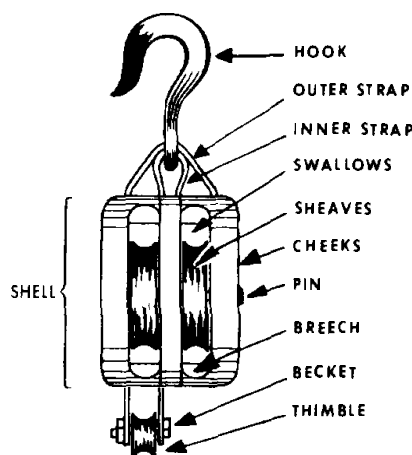

FIGURE 24.—*Pulley in a shell.*

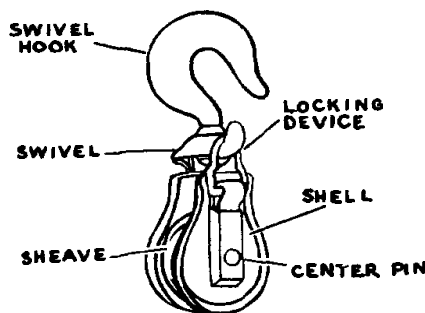

FIGURE 25.—*Snatch block.*

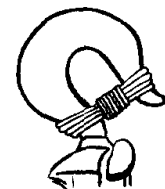

Figure 26.—*Mousing of hook.*

B. Reeving

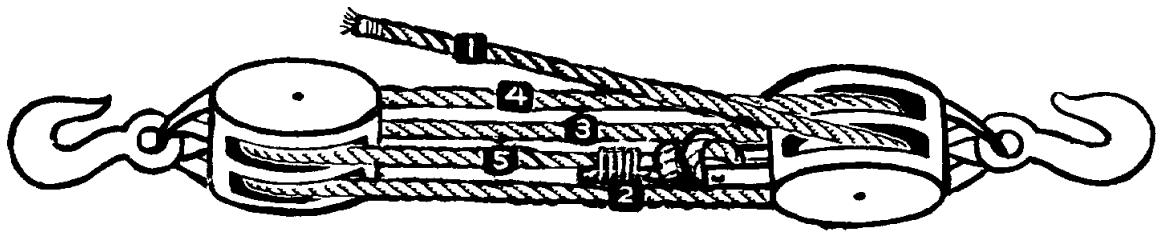

FIGURE 27.—*Double and double.*

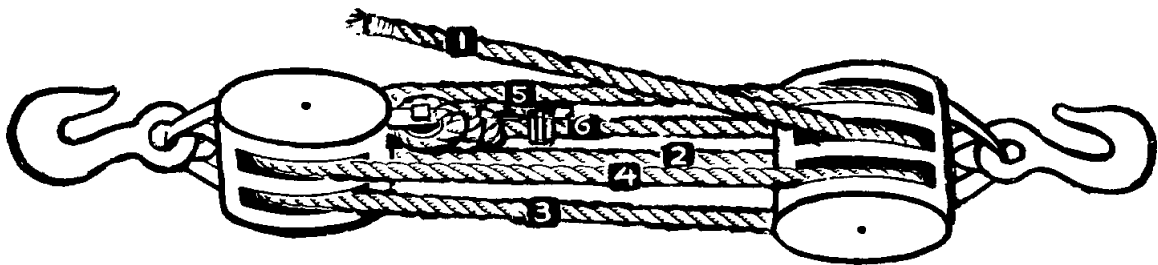

FIGURE 28.—*Triple and double.*

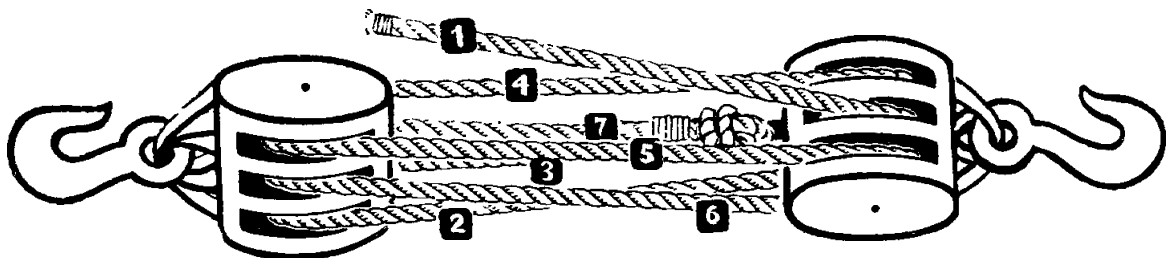

FIGURE 29.—*Triple and triple.*

RIGGING

A. *Gin Pole*

1. Permits movement of the lifted load in any horizontal direction.

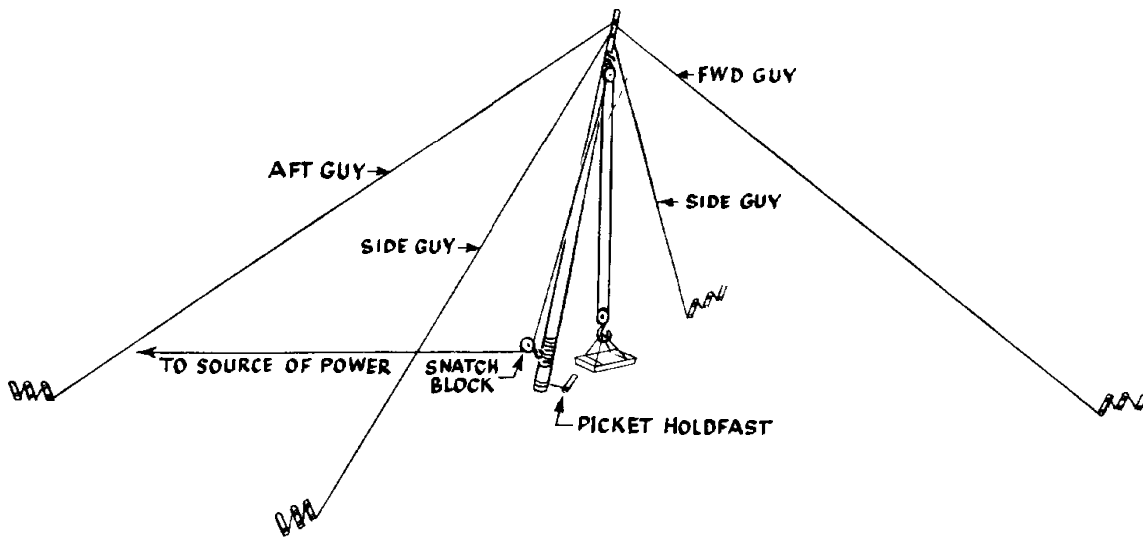

FIGURE 30.—*Gin pole.*

2. Steps.
 - a. Lash top of gin pole.
 - b. Secure and mouse tackle block.
 - c. Lash snatch block to base.
 - d. Tie guy lines to top of gin.
 - e. Prepare base hole.
 - f. Prepare pickets.
 - g. Raise gin pole into position.
 - h. Secure to pickets.

B. Sheerlegs (A-Frame)

1. Used for lifting relatively heavy loads horizontally.

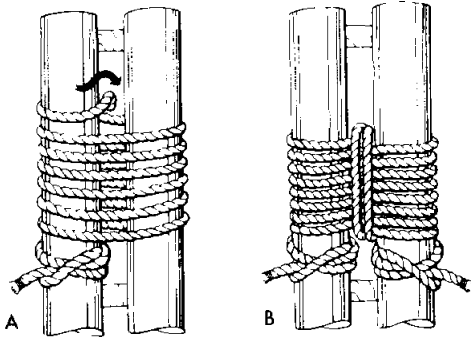

FIGURE 31.—*Making round lashings.*

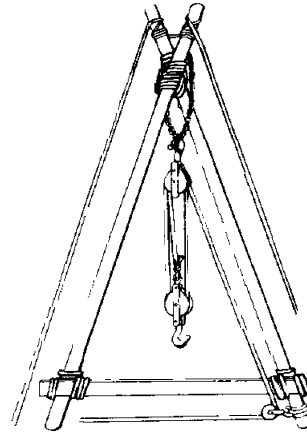

FIGURE 32.—*Lashing and rigging sheerlegs.*

2. Steps.

- a. Place poles side by side with butts even.
- b. Insert spreader block between poles.
- c. Lash.
- d. Turn on edge and spread legs apart to desired angle.
- e. Prepare sling and tackle.
- f. Attach fore and aft guy lines.
- g. Prepare holdfasts.
- h. Prepare base holes.
- i. Raise and secure.

C. Tripod

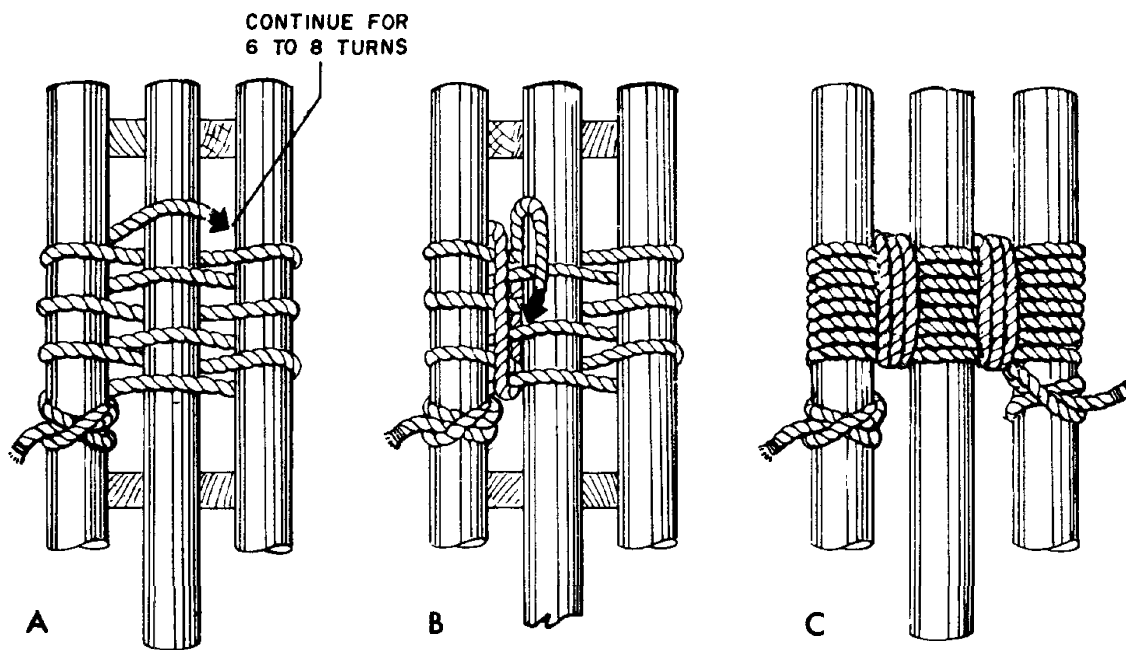

FIGURE 33.—*Making figure-eight lashing.*

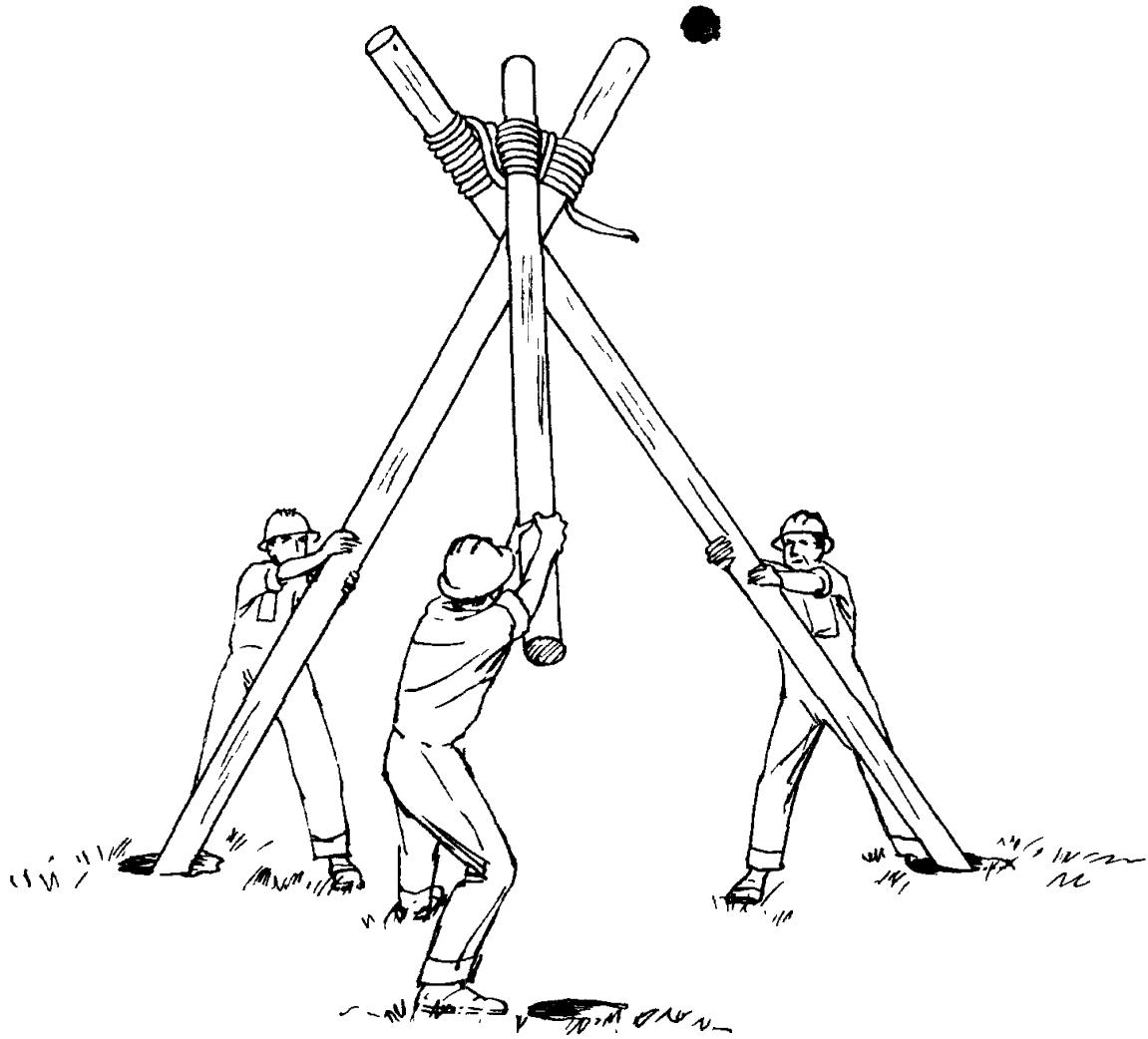

FIGURE 34.—*Raising and placing tripod.*

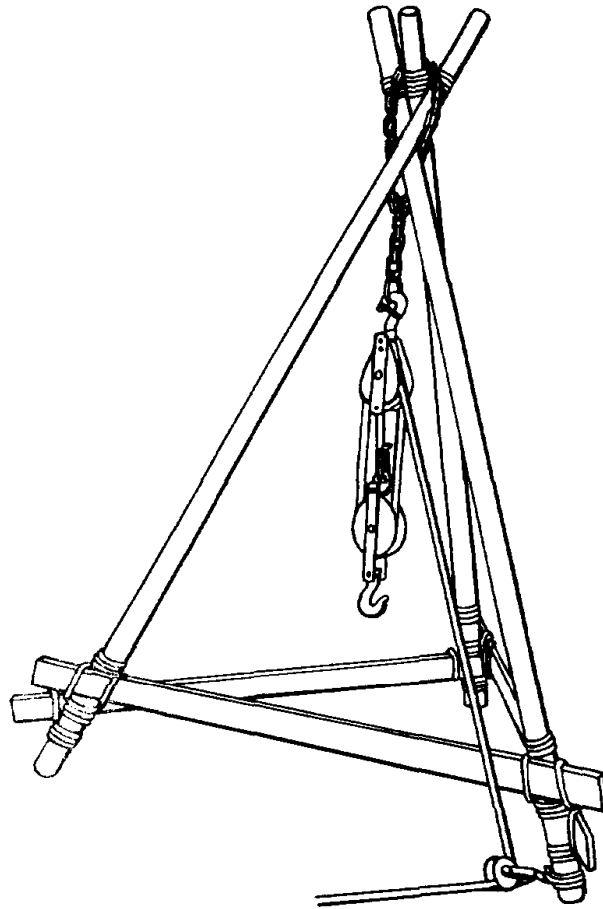

FIGURE 35.—*Lashing and rigging tripod.*

1. Steps.
 - a. Lay three poles parallel with butts even.
 - b. Chamfer edges where lashing is to be applied.
 - c. Spread and insert spreader.
 - d. Lash (figure-eight).
 - e. Remove spacers.
 - f. Raise butts of outside timbers and cross, forming a "V" in which the top of the middle timber will rest.
 - g. Spread timbers to desired distances.
 - h. Prepare holes for firm footing.
 - i. Raise and place—see figure 33.
 - j. Place sling.
 - k. Secure snatch block.

D. *Jib Arm*

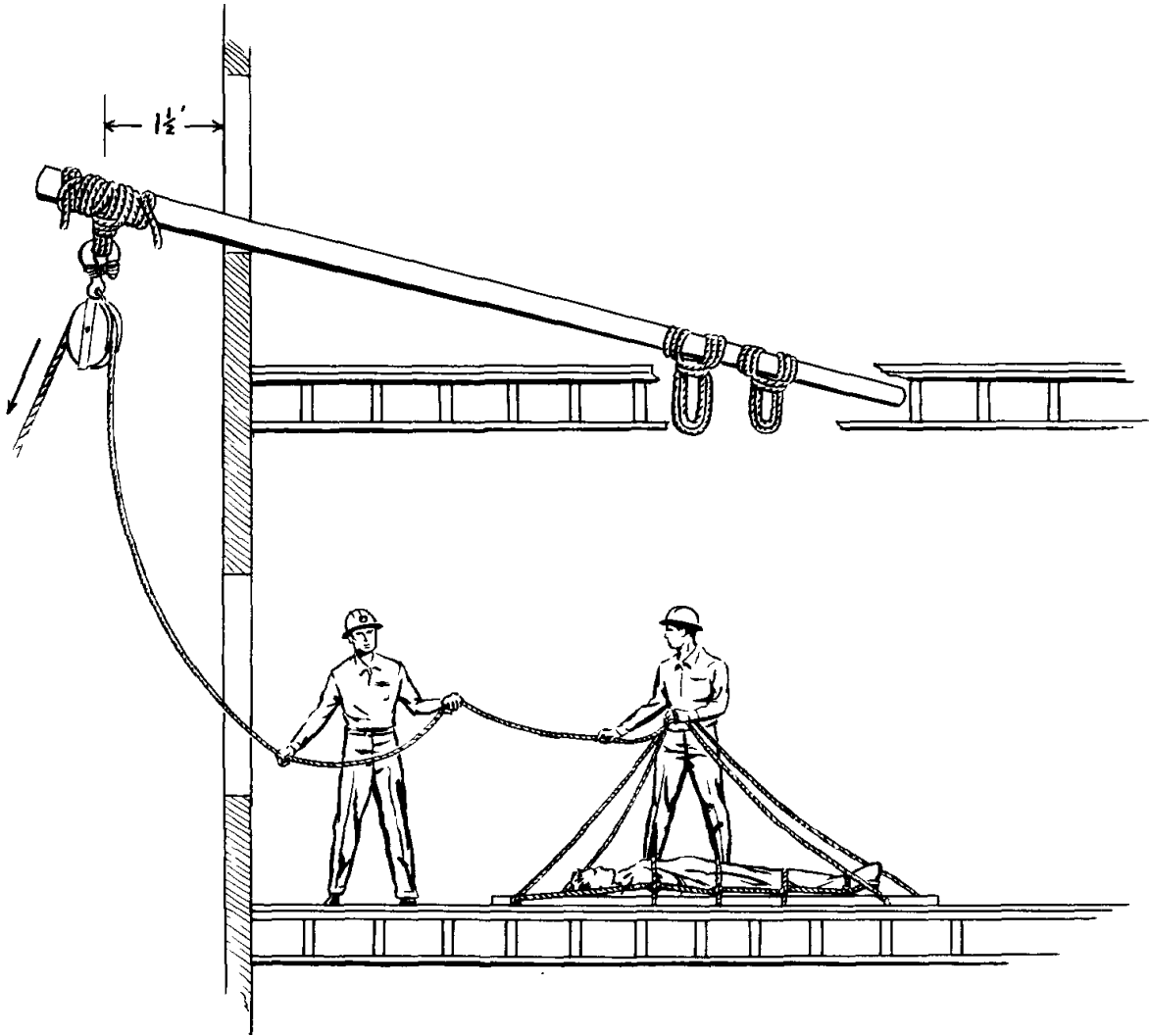

FIGURE 36.—*Jib arm.*

1. Steps.
 - a. Secure proper size timber or pole.
 - b. Secure block to pole.
 - c. Mouse the hook.
 - d. Place and secure jib.

SHORING

A. *Dead or Vertical Shore*

1. Used to support deadweight and protect casualties or rescue workers from danger of further collapse of structure.
2. Parts.
 - a. Solepiece or bearing plate.
 - b. Headpiece.
 - c. Main shore.
 - d. Wood wedges.

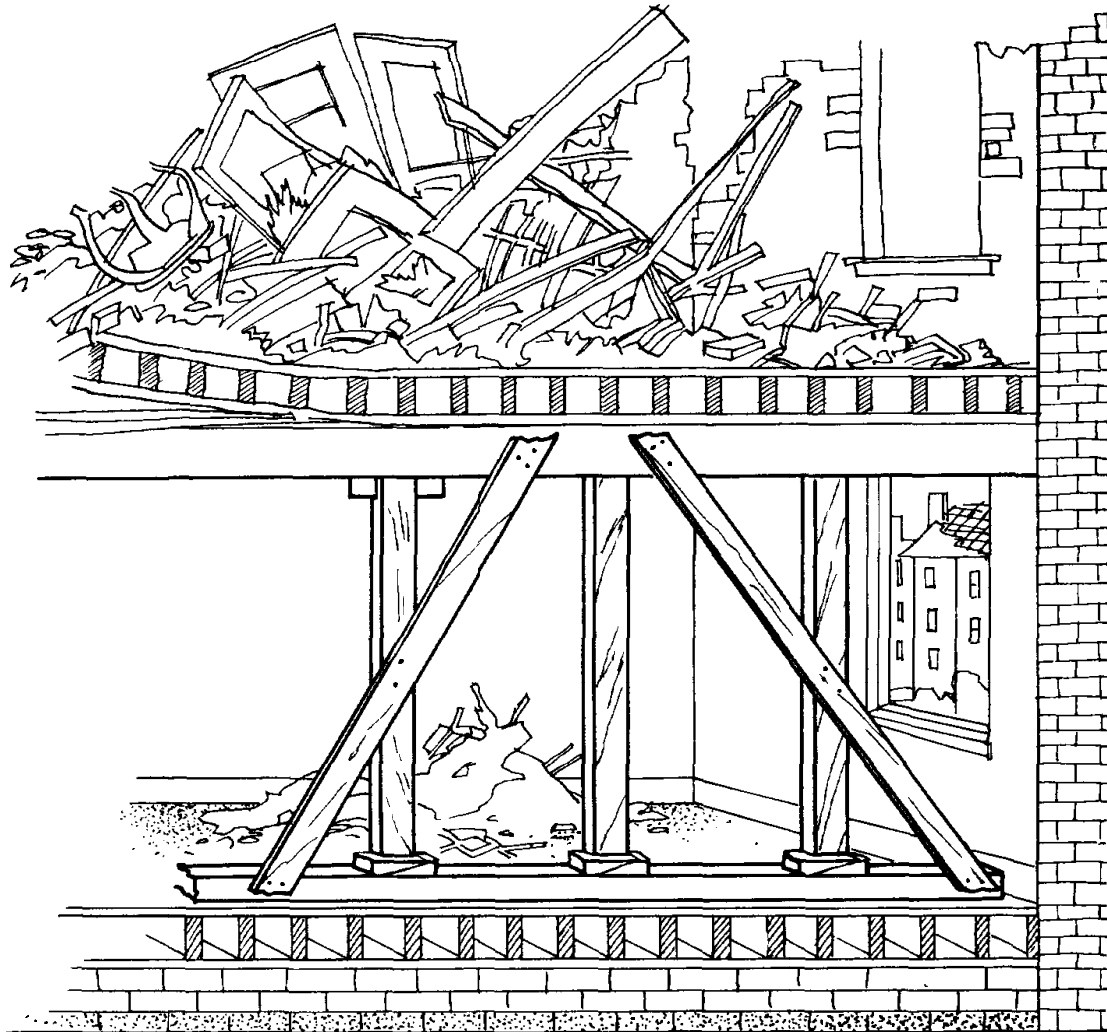

FIGURE 37.—*Dead or vertical shore.*

B. *Raking Shore*

1. Used to brace a wall that is bulging or out of plumb and in danger of collapse.
2. Parts.
 - a. Wallplate.
 - b. Raker.
 - c. Sole or bearing plate.
 - d. Wood wedges.
 - e. Cleats.

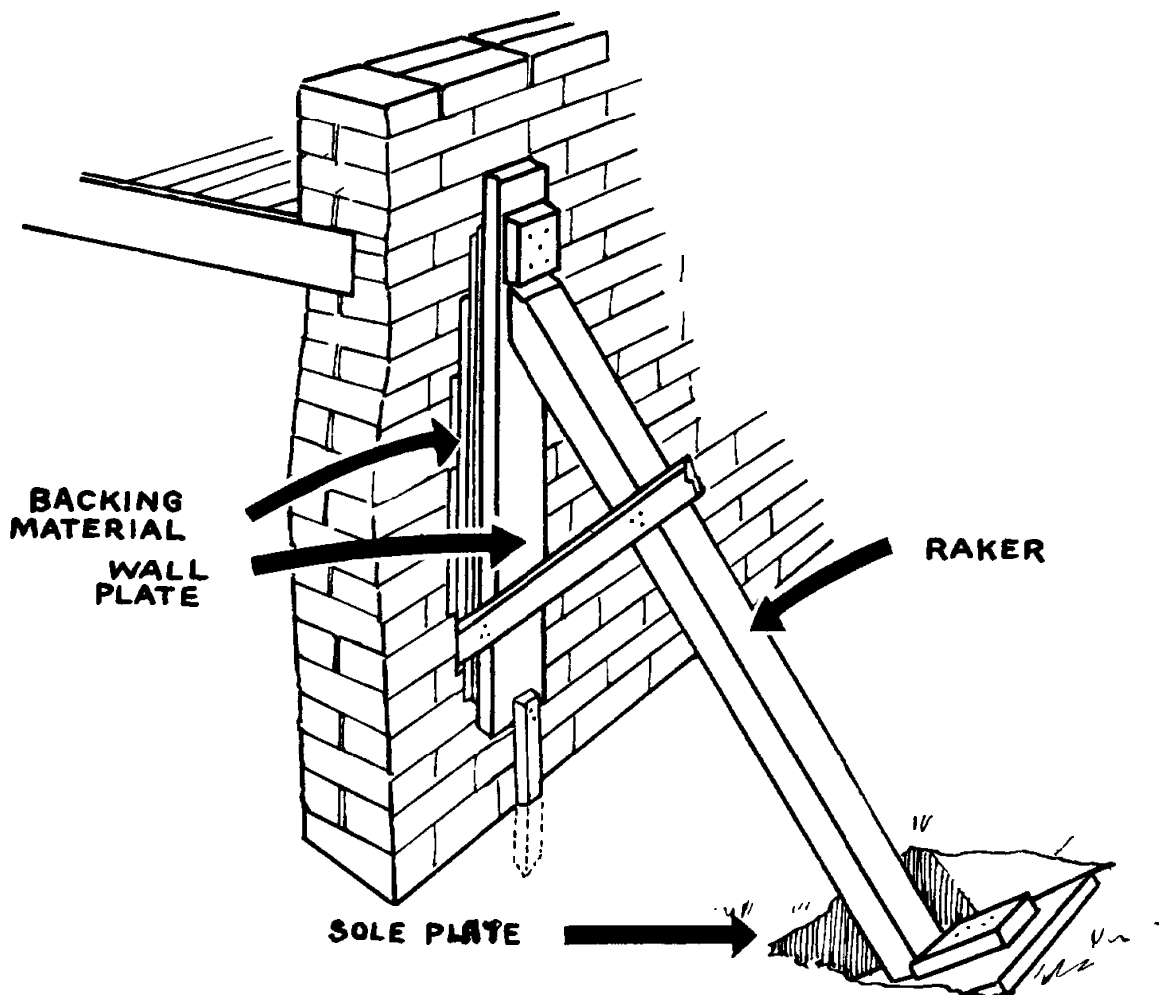

FIGURE 38.—*Raking shore.*

C. *Flying Shore*

1. Used to brace a wall when a sound wall is near enough to serve as a footing.
2. Parts.
 - a. Horizontal beam.
 - b. Wallplates.
 - c. Struts.
 - d. Straining pieces.
 - e. Cleats and wedges.
3. Limitations.
 - a. Not to exceed 25-foot span.

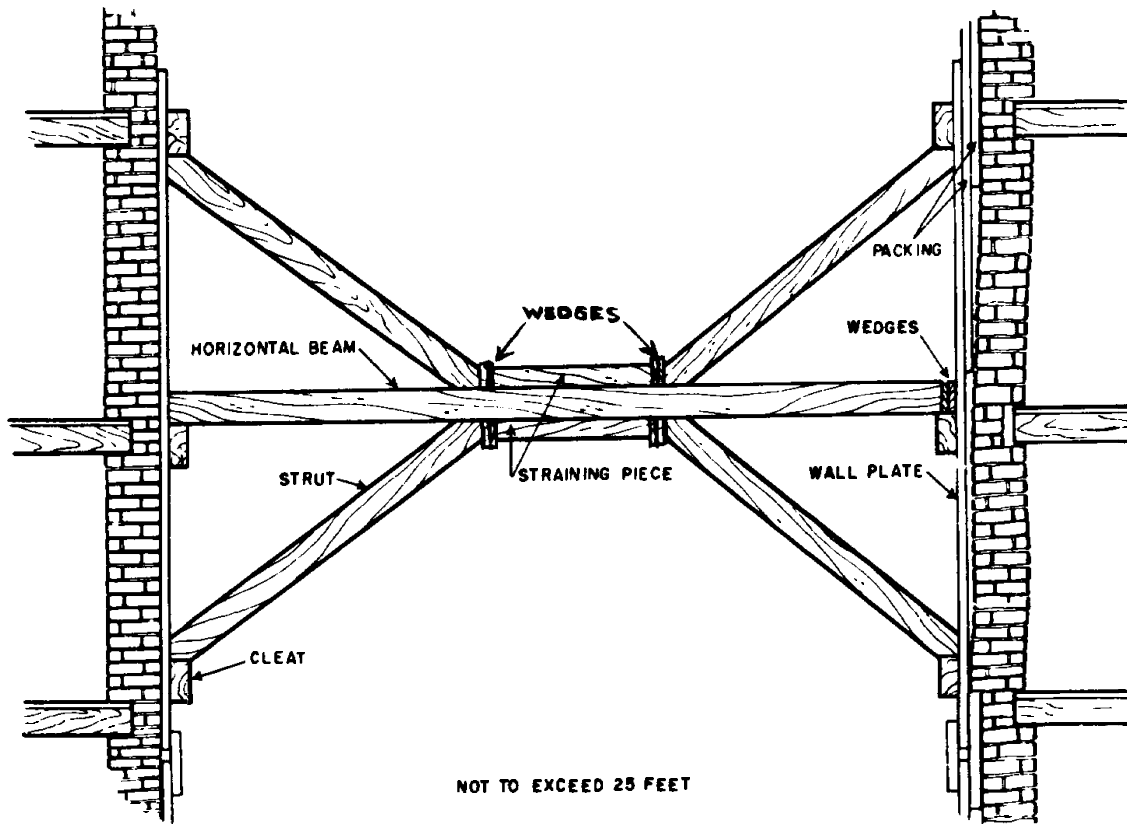

FIGURE 39.—*Flying shore.*

D. *Strutting Window Openings*

1. Used to strengthen window and door frames made unsafe by cracked or damaged walls.

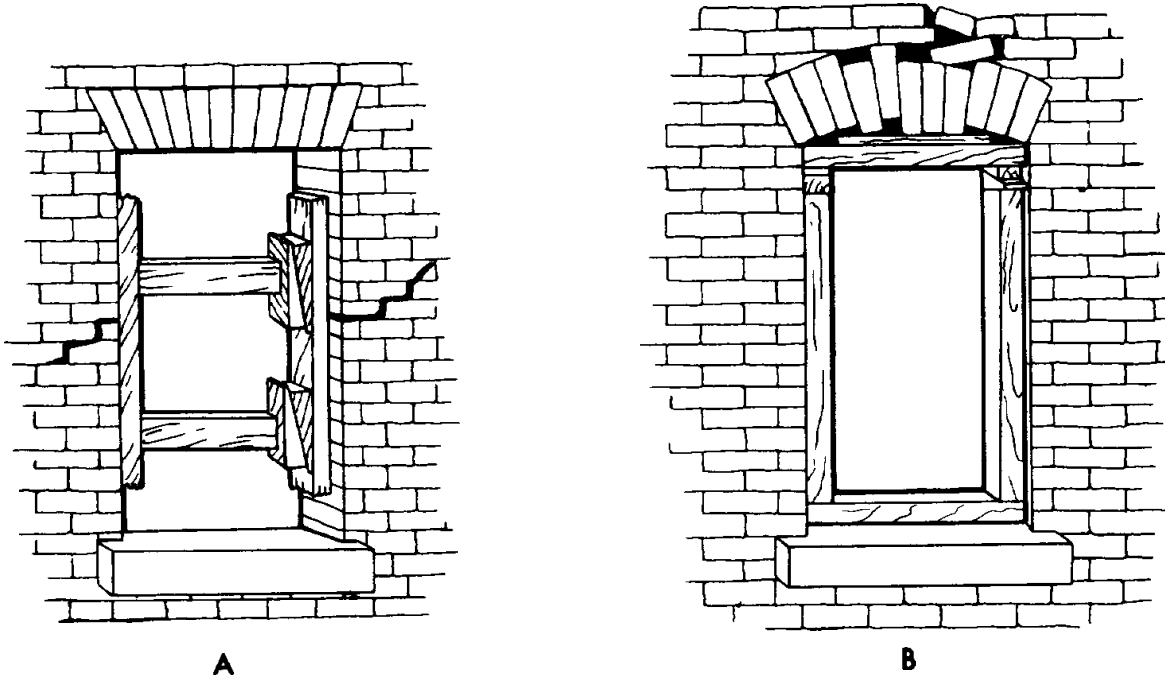

FIGURE 40.—*Strutting window openings.*

WALL BREACHING

A. *Purpose*

1. To gain entry into buildings through basements or walls to rescue casualties, it may be necessary to breach walls. Breaching is hard work, but much effort can be saved by a methodical approach. Rescuers should know something about material used in walls.

B. *Types of Walls*

1. Brick with lime mortar—least difficult.
2. Brick with cement mortar—the cement is usually as strong as the brick.
3. Stone—usually thick and difficult to cut.
4. Concrete—very difficult to cut through; impact tools should be used if possible.

C. *Cautions*

1. When cutting through any material but solid concrete, start with a small hole and enlarge as necessary.
2. When cutting through concrete, cut around the edge of the piece to be removed.
3. When an oxyacetylene torch is used, be careful not to ignite combustible debris. Make sure that utility gas is not present and ventilation is provided.

BASEMENT RESCUE

A. *Approach*

1. To rescue from basements rescuers should first learn the layout of the basement and its entrances and exits, including windows, chutes, and manholes. Much of this information may be obtained from other civil defense workers, neighbors, and released victims. The squad leader's approach to a basement rescue will depend on:
 - a. Condition of the demolished building.
 - b. Amount of debris obstructing entry.
 - c. Feasibility of approach through debris to exits.
 - d. Feasibility of approach from upper floors.
 - e. Time available.

HIGH RESCUE

A. *Vertical Lower Out Window*

1. Steps.

- a. Select proper equipment.
- b. Prepare stretcher.
- c. Attach lowering rope.
- d. Attach guidelines.
- e. Ease stretcher out window.
- f. Anchorage must carry weight.

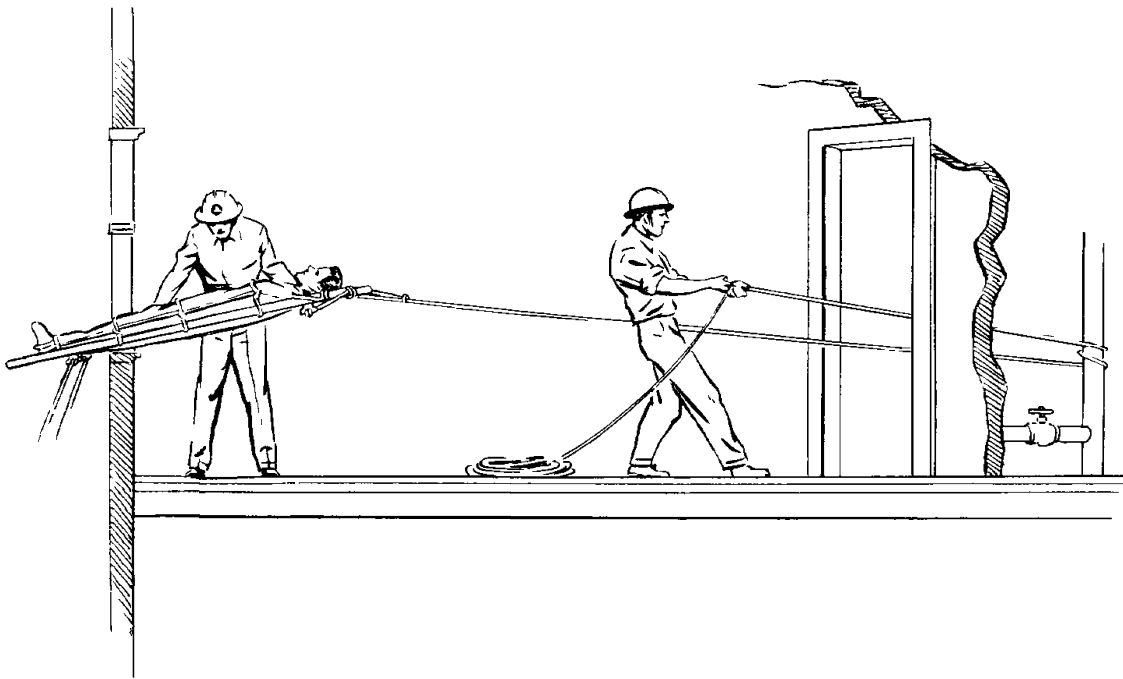

FIGURE 41.—*Close-to-wall vertical lower.*

B. *Stretcher Slide*

1. Steps.

- a. Select proper equipment.
- b. Prepare stretcher.
- c. Place ladder properly.
- d. Secure ladder.
- e. Secure head rope.
- f. Place stakes through D-rings.
- g. Begin stretcher slide.
- h. Man on ladder and beneath stretcher controls the operation.

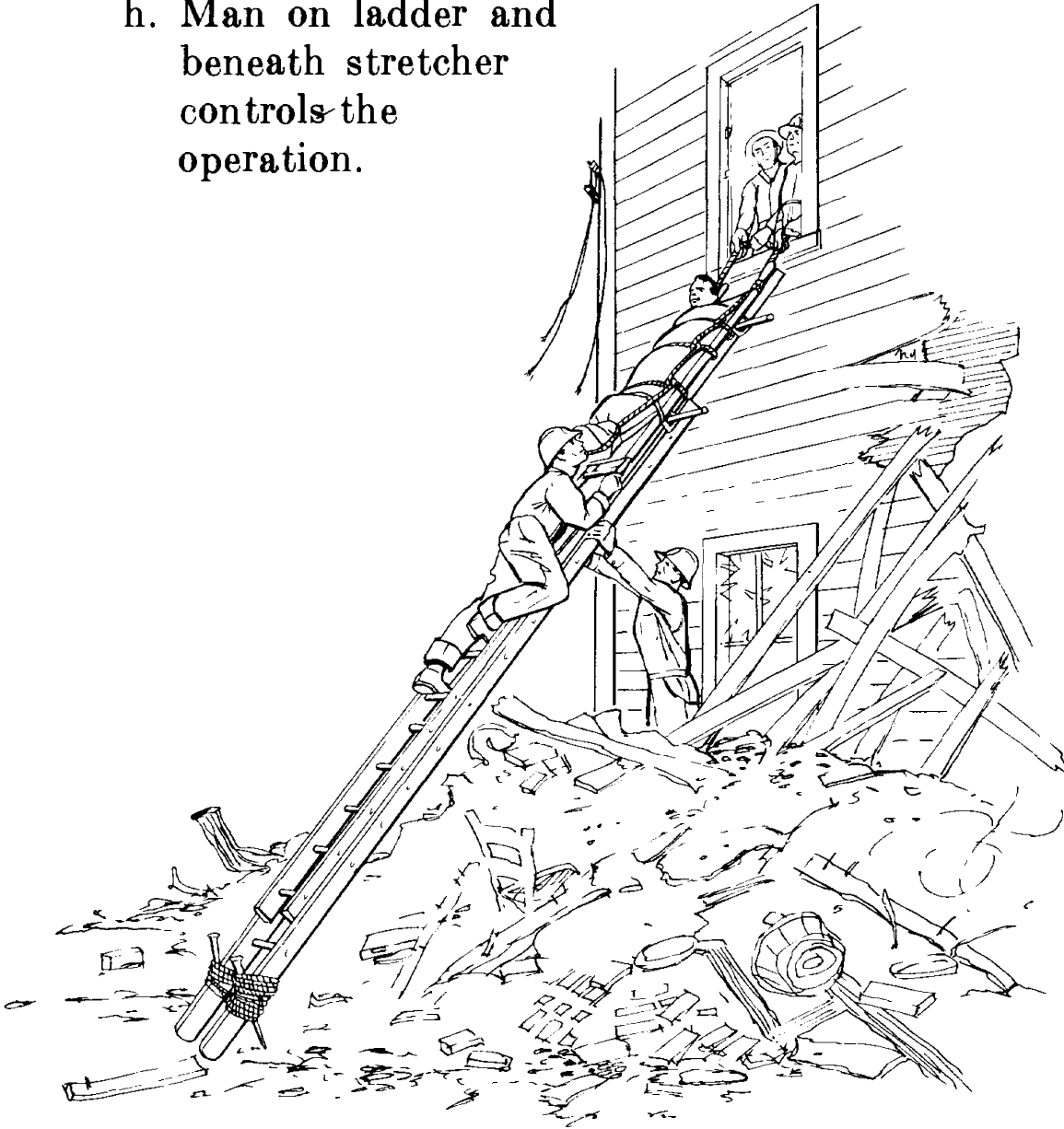

FIGURE 42.—*Stretcher slide from second story window.*

C. *Telpher*

1. Steps.

- a. Select proper equipment.
- b. Anchor both ends of telpher.
- c. Prepare stretcher for lower.
- d. Properly distribute the available rescue manpower.

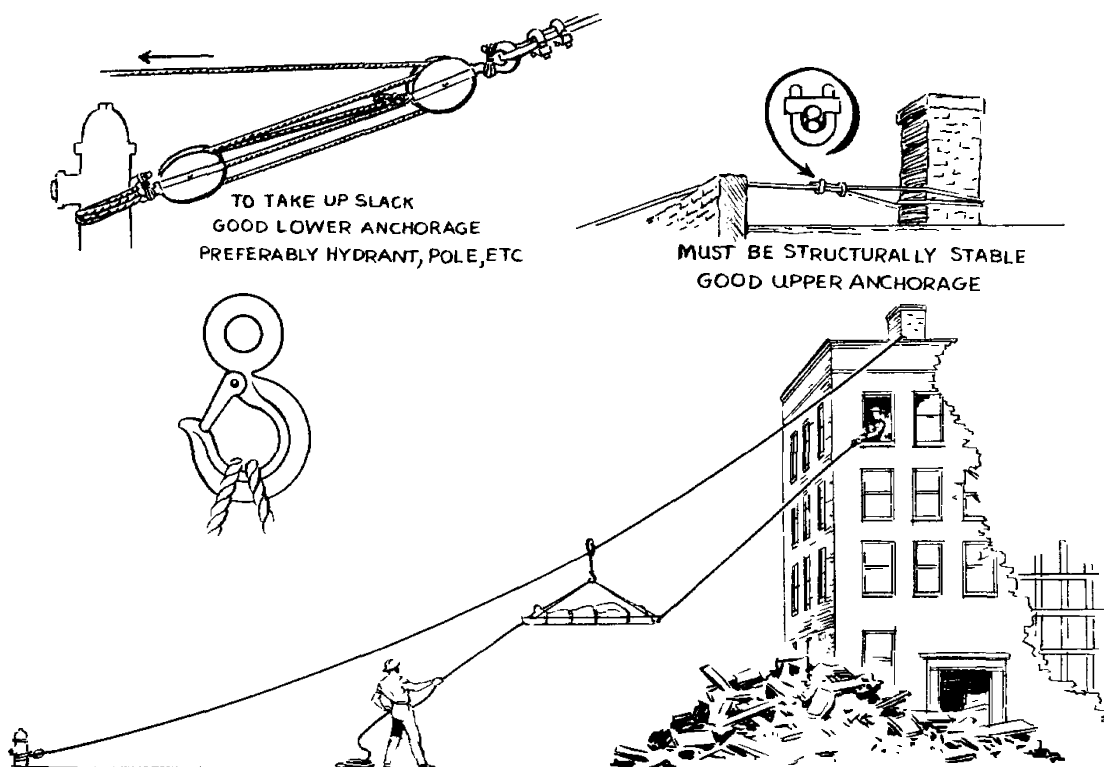

FIGURE 43.—*Telpher line.*

D. *Jib*

1. Steps.

- a. Select proper equipment.
- b. Place jib after block and tackle has been attached.
- c. Prepare stretcher for lower.
- d. See figure 35, page 31.

TRENCHING, TUNNELING, AND SHAFTING

A. *Trenching*

1. Should not be attempted if debris is more than 8 feet in height.
2. Steps.
 - a. Select area carefully.
 - b. Assemble materials to support sides.
 - c. Remove debris.
 - d. Erect sides of trench.
 - e. Place braces to support sides.

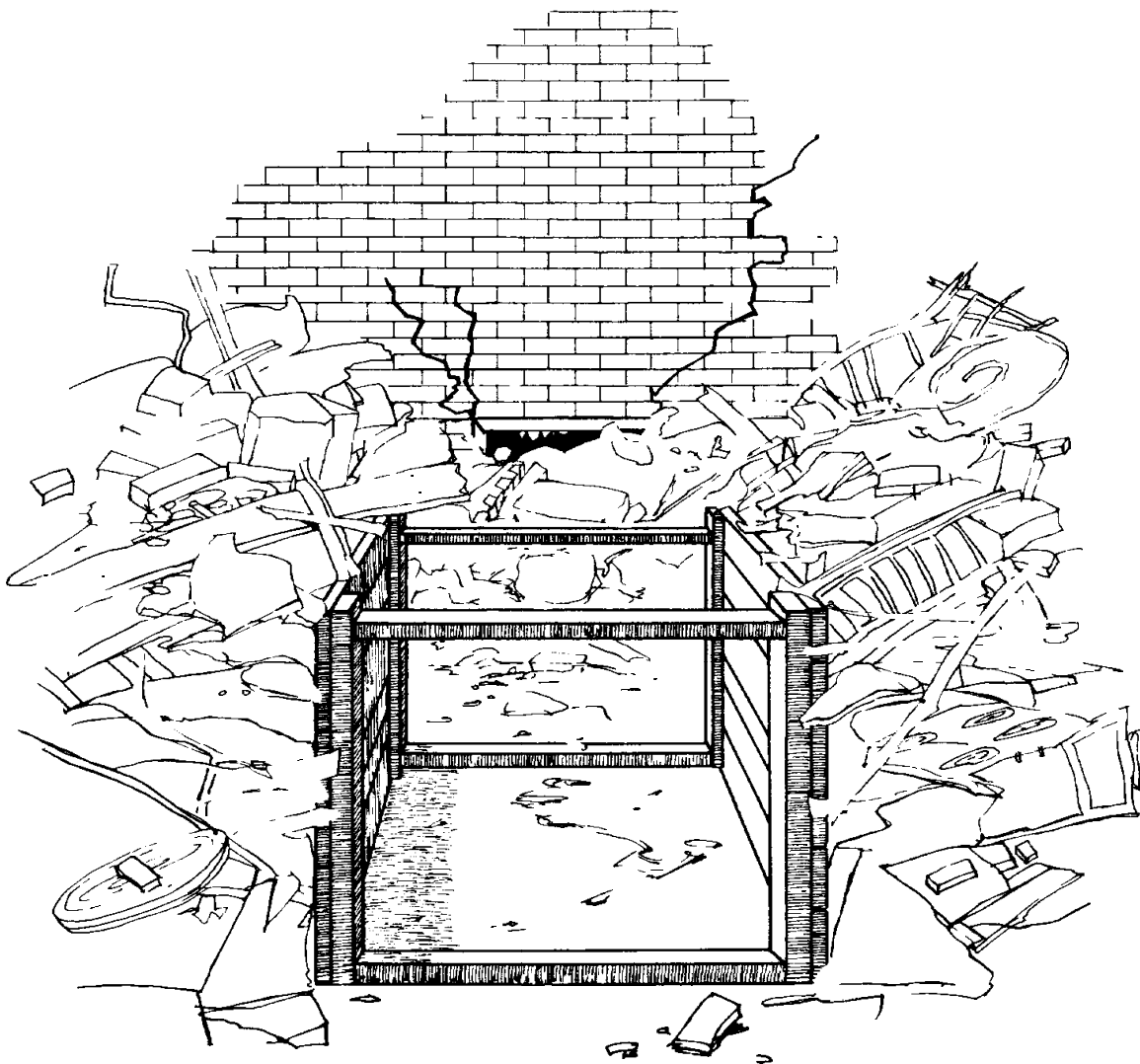

FIGURE 44.—*Trenching.*

3. Precautions.

- a. Avoid unnecessary movement of debris pile.
- b. Prohibit rubble crawling.
- c. Wear helmet and protective gloves.
- d. Avoid overstrain and fatigue.

B. *Tunneling*

1. Most hazardous method for rescuers and trapped persons.

DEBRIS TUNNELING CONSTRUCTION OF TUNNEL

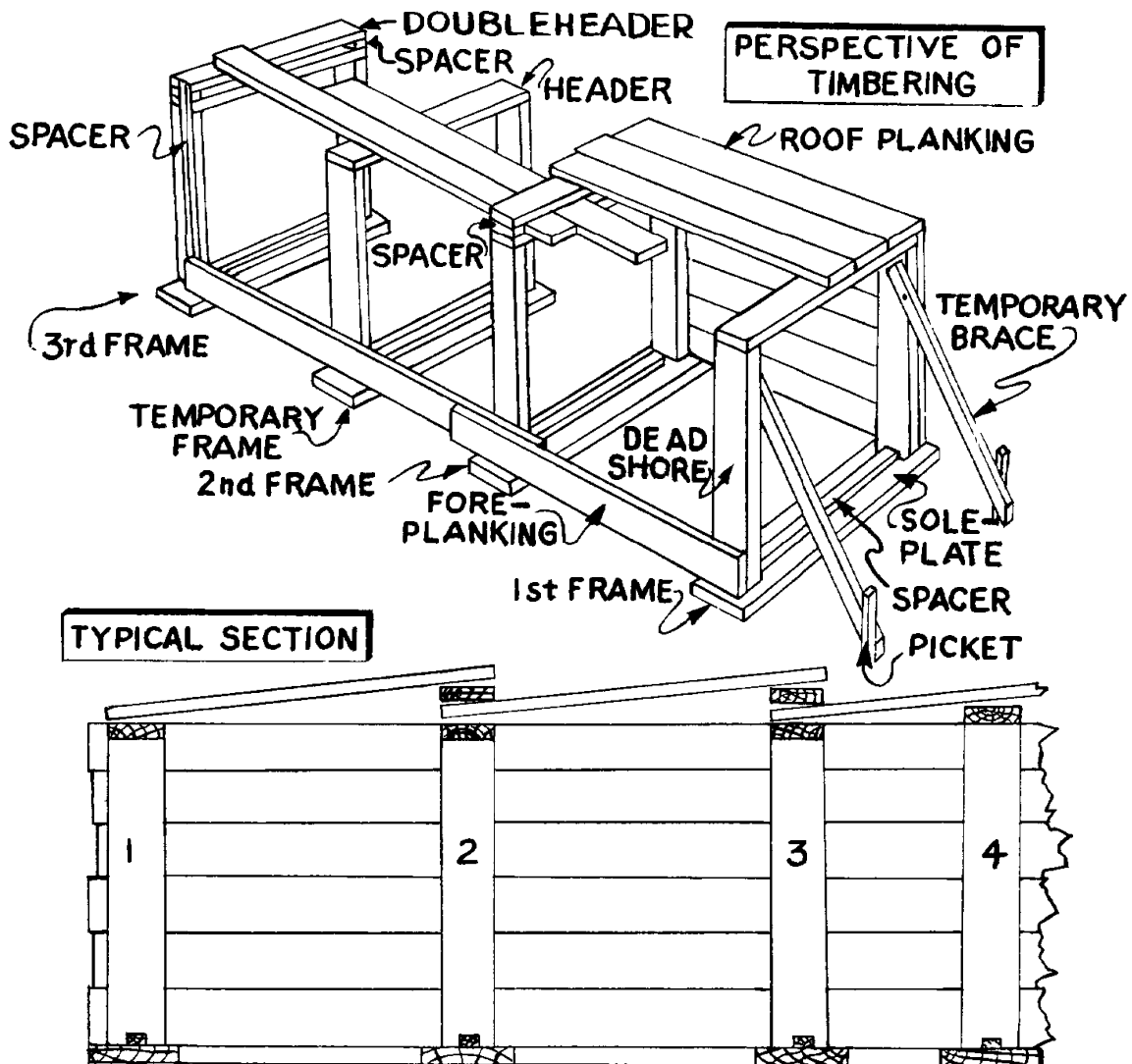

NOTE 1-2-3 PERMANENT FRAMES
4 TEMPORARY FRAME

FIGURE 45.—*Tunnel construction.*

2. Steps.
 - a. Determine location of trapped person.
 - b. Select starting point.
 - c. Make maximum use of voids.
 - d. Deploy rescue manpower properly.

C. *Shafting*

1. Used where tunneling is impracticable because of distance to be worked.

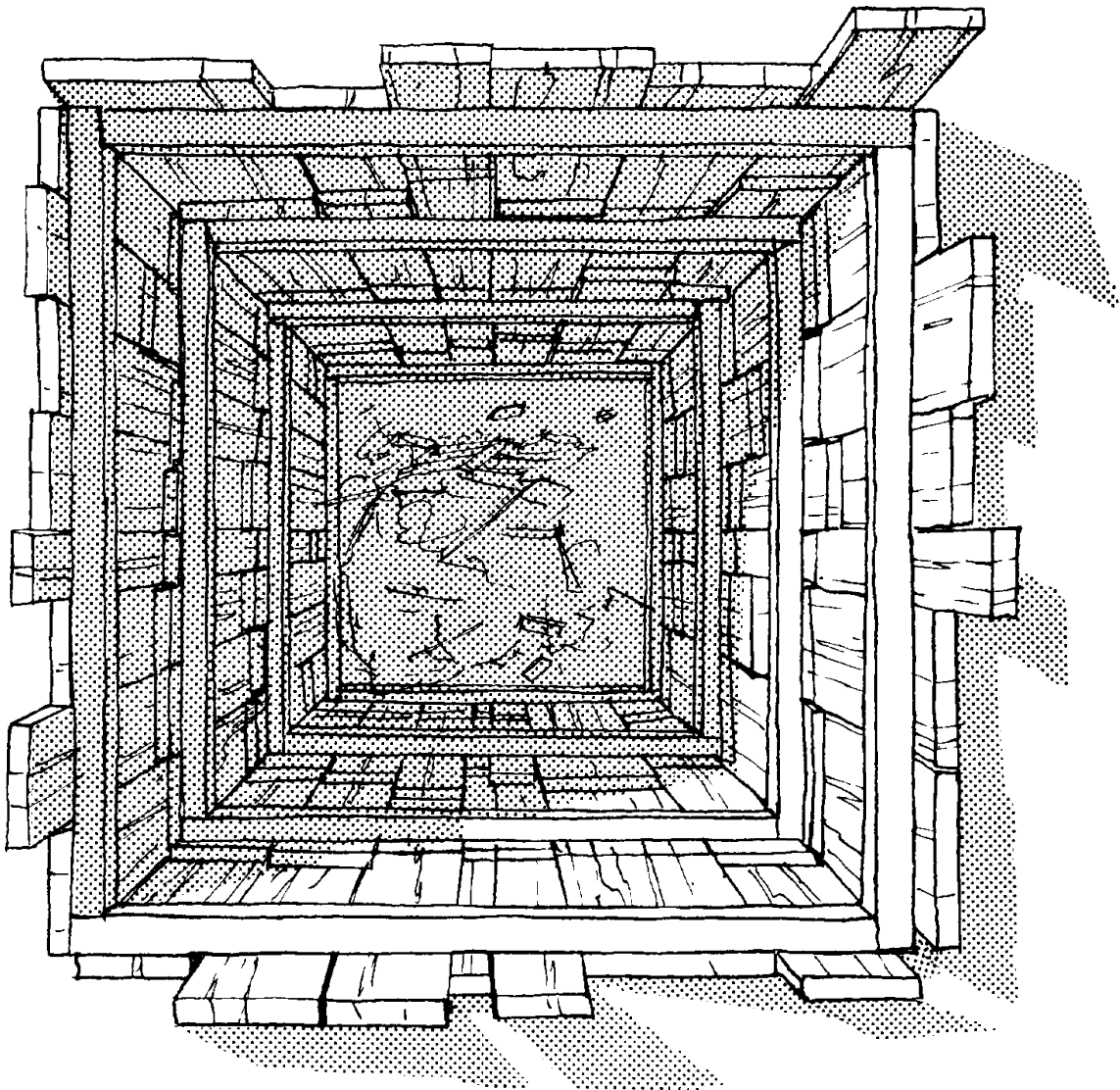

FIGURE 46.—*Shaft.*

MASKS

A. *Points to Emphasize*

1. Mask limitations.
2. Principles of operation.
3. Maintenance and care.

B. *Lifeline*

1. A means of communication for members of the rescue party who must enter hazardous enclosures or toxic atmosphere. It enables them to keep in contact with persons outside by sending rope signals.
2. Standard signals.
 - a. One pull—stop (if moving), O. K. (if at rest).
 - b. Two pulls—advance.
 - c. Three pulls—come out at once.
 - d. Four pulls—distress, need help.

EQUIPMENT

The equipment listed is in two categories—*light duty* and *heavy duty*. The quantity of items in each is ample for a team. The CD item number refers to specifications (available from the Office of Civil Defense).



FIGURE 47.—*Light duty rescue truck and equipment.*



FIGURE 48.—*Heavy duty rescue truck and equipment.*

*A. Standard Light Duty Rescue Tools and Equipment Per
Team of 4 Men*

<i>CD item No.</i>	<i>Description</i>	<i>Quantity per set</i>
VIII-4	Band, webbing, for casualty handling	1
VIII-150	Bar, wrecking, ½" x 12" long, gooseneck, claw and pinch point.	2
VIII-7	Bar, wrecking, 1" x 30" long, gooseneck, claw and pinch point.	2
VIII-12	Blanket (cotton and wool)	4
VIII-13	Boots, rubber, pullover, shoe, short (pair)	4
VIII-151	Box, tool, 19" x 7" x 7" w/tray	1
VIII-15	Bucket, type II, galvanized, 14-quart (heavy gage).	2
VIII-16	Can, safety, oil, 1-gal	1
VIII-17	Canteen, wo/cup	4
VIII-19	Chain, 6', 5,000 lbs., close link, type A, class I, grade II, grab hook and ring.	1
VIII-21	Chisel, hand, cold, ¾" x 12"	2
VIII-25	Coat, rain, jacket, medium length	4
VIII-26	Container, debris, bucket type	2
VIII-27	Container, water, drinking, 5-gal. cap	1
VIII-28	Cord, sash, cotton braided, 15' long	4
VIII-152	Cord, whipping, ball	2
VIII-29	Coveralls, 2 medium, 2 large	4
VIII-31	Crayon, lumber marking, red, yellow	6
VIII-175	Extinguisher, water, hand pump, 4-gal	1
VIII-41	Gloves, heavy debris (pair)	4
VIII-154	Gloves, leather, protective (pair)	1
VIII-42	Gloves, rubber, insulating (pair)	1
VIII-44	Goggles, dustproof, shatterproof	4
VIII-45	Hacksaw, frame	1
VIII-45a	Blade, hacksaw	10
VIII-47	Hammer, sledge, 4-lb. w/handle	1
VIII-48	Hammer, sledge, 8-lb. w/handle	1
VIII-116	Hatchet, carpenter's	2
VIII-50	Helmet, protective, wo/lighting bracket	4
VIII-156	Hydraulic spreading and pulling set, 4-ton cap., in case.	1
VIII-53	Jack, screw, 5-ton cap., w/handle	2
VIII-38	Kit, first aid, belt type, filled, w/1 refill	4

<i>CD item No.</i>	<i>Description</i>	<i>Quantity per set</i>
VIII-157..	Ladder, extension, 20'—2-section.....	1
VIII-67...	Light, safety approved, battery.....	4
VIII-163..	Plier-wrench, type U, class 1, style 1, 8½''	2
VIII-71...	Pliers, 8'', elec., wire-cutting, w/ins. handle...	2
VIII-80...	Rope, manila, ½'' dia., 50' lengths.....	4
VIII-141..	Rope, manila, ½'' dia., 150' lengths.....	2
VIII-160..	Rope, manila, ¾'' dia., 10' lengths.....	2
VIII-129..	Ruler, folding, carpenter's, 6'	2
VIII-86...	Saw, hand, 26'' cutting edge.....	2
VIII-88...	Screwdriver, 16½'', common.....	2
VIII-89...	Sheeting, rubber, black, 45'' wide, 84'' long...	4
VIII-162..	Shovel and pick combination.....	2
VIII-171..	Snatch block, steel; heavy duty, type II, class 2, size 1, 8'' (for wire rope).	1
VIII-161..	Snip, tin, 8½'', common.....	1
VIII-94...	Stakes, metal, 30'' long, 1'' dia.....	4
VIII-95...	Stretcher, latest Army type (canvas).....	2
VIII-124..	Stretcher, Stokes type.....	1
VIII-170..	Supplemental light duty rescue tools and equip- ment, set.	1
VIII-143..	Tackle block, manila rope, 4'' (2-sheave) w/ becket.	2
VIII-164..	Wrench, pipe, adjustable, heavy duty, 14''	2

1 *Supplemental Light Duty Rescue Equipment*

<i>CD item No.</i>	<i>Description</i>	<i>Quantity per set</i>
VIII-138..	Blankets (paper)	4
VIII-125..	Cord, extension, 100', for flood lights w/wye ..	1
VIII-126..	Cord, extension, 50', for flood lights w/wye ..	2
VIII-153..	Clipper, bolt, ¼'', 18'' long, type II, class C ..	1
VIII-139..	Hammer, cross-peen, 3-lb., w/handle	1
VIII-155..	Hoist, winch type, portable, ¾-ton cap	1
VIII-165..	Inhalator, portable, w/case	1
VIII-51...	Jack, ratchet, 5-ton cap., w/lever	2
VIII-56...	Ladder, roof, 12' w/folding hooks	1
VIII-158..	Light, flood, portable, generator powered	2
VIII-119..	Light, red-flashing, battery powered	2
VIII-159..	Power unit, gas driven, 1 kw portable, AC	1
VIII-177..	Resuscitator, mouth-to-mask	1
I-100.....	Radio, mobile, 2-way	1
VIII-87...	Saw, pruning, dbl. edge, 18'' blade	51
V-800.....	Mask, filter-type	4
V-750.....	Radiological dosimeter charger	1
V-740.....	Radiological dosimeter, self-reading	4
V-710.....	Radiological survey meter	1

B. Standard Heavy Duty Rescue Tools and Equipment Per Team of 8 Men

<i>CD item No.</i>	<i>Description</i>	<i>Quantity per set</i>
VIII-1....	Apparatus, self-contained, breathing, each w/3 canisters.	2
VIII-2....	Axe, 4-lb., single bit, w/handles	2
VIII-5....	Bag, burlap, 60 lb.-cap., sand	48
VIII-4....	Bands, webbing, for casualty handling	2
VIII-6....	Bar, pinch, 30'' long	1
VIII-7....	Bar, wrecking, ¾'' gooseneck, claw and pinch point, 30'' long.	2
VIII-10...	Bit, 1'' auger	2
VIII-11...	Blanket, asbestos, protective w/canvas container ..	1
VIII-12...	Blanket (cotton and wool)	8
VIII-13...	Boots, rubber, pullover, shoe, short, U.S. Rubber or equal (pairs).	8
VIII-14...	Brace, ratchet head, 12'' sweep	1

<i>CD item No.</i>	<i>Description</i>	<i>Quantity per set</i>
VIII-15...	Bucket, galvanized, 14-qt. (heavy gage)-----	6
VIII-16...	Can, safety, gasoline, 1-gal-----	1
VIII-17...	Canteen, wo/cup-----	8
VIII-18...	Chain, 6' long, 1,700 lb. cap., w/grab hook and ring.	2
VIII-19...	Chain, 6' long, 5,000 lb. cap., w/grab hook and ring.	1
VIII-20...	Chisel, cold, 7/8" x 8"-----	2
VIII-21...	Chisel, hand, cold, 3/4" x 12"-----	2
VIII-22...	Chisel, cold, 3/4" x 18"-----	2
VIII-25...	Coats, rain, jacket, medium length-----	8
VIII-26...	Container, debris, bucket type-----	8
VIII-27...	Container, water, drinking, 5-gal. cap-----	1
VIII-112...	Can, gas, safety, 5-gal. cap-----	1
VIII-125...	Cord, extension, 100', for floodlights, w/twist lock waterproof connectors.	5
VIII-126...	Cord, extension, 50', for floodlights, w/connectors.	2
VIII-28...	Cord, sash, cotton braided, 15' long-----	8
VIII-29...	Coveralls, 4 medium and 4 large-----	8
VIII-31...	Crayon, lumber marking, red and yellow-----	12
VIII-32...	Crowbar, 66" length, pinch point-----	2
VIII-33...	Crowbar, 72" long, 1 1/2" hexagon handle, w/mushroom and flat ends.	2
VIII-34...	Clipper, bolt, 36" long, 5/8" cap-----	1
VIII-113...	Cutter, pipe, 1/8" to 2", 3-wheel type-----	1
VIII-40...	Gear, lifting tackle, 1 1/2 ton cap-----	1
VIII-41...	Gloves, heavy debris (pair)-----	16
VIII-42...	Gloves, rubber, insulating (pair)-----	2
VIII-44...	Goggles, dustproof, shatterproof-----	8
VIII-45...	Hacksaw, frame, w/10 blades-----	1
VIII-46...	Hammer, claw, 16-oz. w/handle-----	4
VIII-139...	Hammer, ball-peen, 3-lb. w/handle-----	2
VIII-47...	Hammer, sledge, 4-lb. w/handle-----	2
VIII-48...	Hammer, sledge, 8-lb. w/handle-----	2
VIII-49...	Hammer, sledge, 16-lb. w/handle-----	1
VIII-116...	Hatchet, carpenter's-----	2
VIII-103...	Heater, unit, single-burner, gasoline-----	1
VIII-50...	Helmet, safety (luminescent)-----	8

<i>CD item No.</i>	<i>Description</i>	<i>Quantity per set</i>
VIII-51	Jack, ratchet, 5-ton cap, w/lever	2
VIII-52	Jack, ratchet, 15-ton cap., w/lever	2
VIII-53	Jack, screw, 5-ton cap	2
VIII-38	Kit, first aid, belt type, w/contents, plus one refill in separate container.	8
VIII-56	Ladder, roof, 12' w/folding hooks	1
VIII-57	Ladder, extension, 28'—2-section	1
VIII-117	Ladder, collapsible, 10'	1
VIII-119	Light, red-flashing, battery powered	4
VIII-59	Light, flood, portable, generator powered	3
VIII-67	Light, safety approved, battery	8
VIII-114	Mask, gas, filter type, w/case and 2 canisters	4
VIII-66	Outfit, cutting, oxygen-acetylene, w/goggles and gloves, 2 spare oxygen tanks, 1 spare acetylene.	1
VIII-68	Pick, point, and chisel, w/handle	2
VIII-69	Pick, poll, or mining, w/handle	2
VIII-70	Pliers, 8'', comb., slip joint w/cutter	4
VIII-71	Pliers, 8'', wire-cutting, w/ins. handle	1
VIII-118	Pole, pike, 8'	1
VIII-72	Power unit, gas. drive, 2½ kw portable, AC	1
VIII-73	Pump, stirrup, w/20' hose and jet nozzle	1
VIII-80	Rope, manila, ½'' dia., 50' lengths	8
VIII-141	Rope, manila, ½'' dia., 150' lengths	4
VIII-81	Rope, manila, ¾'' dia., 200' lengths	1
VIII-82	Rope, manila, ¾'' dia., 300' lengths	1
VIII-142	Rope, manila, 1'' dia., 300' lengths	1
VIII-77	Rope, wire, ¼'' dia., 15' lengths, w/looped and whipped ends for lashings.	6
VIII-78	Rope, wire, ⅜'' dia., 10' lengths, w/spliced and loop ends.	2
VIII-79	Rope, wire, ⅝'' dia., 50' lengths w/thimble and hook.	2
VIII-129	Ruler, folding, carpenter's, metals, 6'	1
VIII-84	Saw, chain, elec., 18'' w/extension cord and extra chain.	1
VIII-85	Saw, crosscut, 4½' blade	1
VIII-86	Saw, hand, 26'' length (8 point)	1
VIII-121	Saw, floor, silver steel, 18'' long (8 point)	1

<i>CD item No.</i>	<i>Description</i>	<i>Quantity per set</i>
VIII-122--	Saw, power, elec., portable, 8'' w/case-----	1
	Blades: Combination-----	2
	Nailcutting-----	2
	Carboloy-----	2
VIII-87---	Saw, pruning, dbl. edge, 18'' blade-----	1
VIII-88---	Screwdriver, common, 16½''-----	1
VIII-123--	Shears, tinnern, 12'' (snips)-----	1
VIII-89---	Sheeting, rubber, black, 45'' wide, 84'' long--	8
VIII-90---	Shovel, pointed, long handle-----	2
VIII-91---	Shovel, square mouth, D-handle, 18''-----	2
VIII-92---	Shovel, tunnelling, short-----	2
VIII-94---	Stake, metal, 30'' long, 1'' dia-----	8
VIII-95---	Stretcher, latest Army type (canvas)-----	4
VIII-124--	Stretcher, Stokes type-----	1
VIII-144--	Tackle block, manila rope, 8'' (snatch)-----	1
VIII-96---	Tackle block, manila rope, 6'' (2-sheave)-----	2
VIII-97---	Tackle block, manila rope, 6'' (3-sheave)-----	2
VIII-98---	Tackle block, manila rope, 6'' (single-sheave snatch).	2
VIII-143--	Tackle block, manila rope, 4'' (2-sheave)-----	8
VIII-147--	Tackle block, 5/8'' wire rope (single snatch)---	2
VIII-137--	Tape, 50' metallic, graduated in inches and sixteenths.	1
VIII-102--	Tarpaulin, 8' x 10'-----	1
VIII-101--	Telephone set, self-energizing, w/400' of wire, complete.	1
VIII-107--	Wrenches, pipe, 24''—Stillson-----	2
VIII-108--	Wrenches, adjustable, crescent, 12''-----	1

Supplemental Heavy Duty Rescue Equipment

<i>CD item No.</i>	<i>Description</i>	<i>Quantity per set</i>
VIII-138--	Blankets (paper)-----	4
VIII-176--	Line throwing life gun w/case-----	1
VIII-177--	Resuscitator, mouth-to-mask-----	1
V-730-----	Radiological dosimeter w/container for 8-----	8
V-740-----	Radiological dosimeter w/container for 8-----	8
V-750-----	Radiological dosimeter charger-----	1
V-710-----	Radiological survey meter-----	2
I-100-----	Radio, mobile, 2-way-----	1

